

New Eight-Tube Super-Heterodyne Construction Article This Issue; How to Balance-Out Neutrodyne Set; Advance Programs for the Week

# Radio Digest

EVERY WEEK **Illustrated** PROGRAMS **TEN CENTS**

REG. U. S. PAT. OFF. & DOM. OF CANADA

Vol. IX Copyright 1924 By Radio Digest Publishing Co. SATURDAY, MAY 3, 1924 No. 4

## TURN LIGHT INTO SOUND



Ruth St. Denis, America's Premiere Danseuse, who recently talked on the "Art of Dancing" from WOR, Newark. White Photo

Vera Featherly (below), popular prima donna heard recently from Westinghouse KYW, Chicago.



Ann Joseffer (extreme right), "The Magic Girl of WGR," won a name for herself among the Radiophans on her first appearance before the microphone. Miss Joseffer is a regular, charming American girl, seventeen years old and can make a violin sing, weep or talk.

### Puts Radio Waves on Telephone Lines

Transmits Concerts into Homes That Lack Airphones; Apparatus Kept Secret

OMAHA, NEBR.—By means of an invention just perfected by A. J. P. Bertschy, engineer, of this city, Radio waves received on Bertschy's apparatus can be converted so as to be projected on telephone lines and re-transmitted into homes where there are no Radio receiving sets. In a series of recent tests conducted by the inventor, music and speech transmitted from WOAW and WAAW, Omaha station, was converted and repeated over land lines with the strength and clarity of a good-working crystal detector set.

### "Classic or Jazz—Which Most Popular?" Prize up

NEW YORK.—Paul Specht, WJZ and WJY broadcast artist and orchestra director, is offering a portable phonograph and a set of his talking machine records for the best 100-word essay on whether classic or jazz is the most popular form of musical entertainment.

There are no rules other than that letters should be limited to 100 words.

### FRENCH USE BRIGHT RAYS FROM STARS

Inventor Claims to Have Heard Distant Capella—Astronomers Interested in Tests

### Four Electrodes Amplify

General Gustave Ferrié, Radio Expert, Demonstrates Invention Before French Academy of Science

(By F. M. Delano, Special Correspondent) PARIS.—Details of the recent successful experiments of General Gustave Ferrié in changing starlight to actual audible sounds, have become public with the demonstration of the invention before the French Academy of Science. Again, the important and indispensable vacuum tube, this time one with four electrodes instead of the customary three, has made a new scientific step possible.

**Discovery of Great Importance** General Ferrié is a Radio expert and chief of communications of the French army. While fantastic in its first announcement, the discovery of the general is genuine and may mean much in the study of astronomy.

(Continued on page 2)



### TONE BROADCAST TO VIOLIN CONNOISSEUR

CHICAGO.—In response to a request from a violin connoisseur in Boston, Lyon & Healy, music dealers here, recently sent one of their Stradivarius violins from their internationally famous Partello Collection to the Drake Hotel where its wonderful tone was broadcast by Station WDAP. Radiophans listening in on the regular Drake concert reported that the tone came through perfectly. This instrument was played by Henri Calinger.



# AMERICAN SOCIETY'S COMPLAINTS HEARD

## BROADCASTERS CLAIM WIN AT DILL BILL CONFAB

Charles H. Tuttle, N.B.A. Counsel, Stars as He Shoots Music Publishers' Testimony to Pieces

WASHINGTON, D. C.—Leading musicians, authors, composers and publishers appeared before the Senate Committee on Patents on April 17 and 18, in opposition to the Dill Radio Copyright Bill. The opposition included many members of the American Society of Composers, Authors and Publishers and a few non-members. If anyone, the broadcasters won both days. The bill then went to the subcommittee for consideration.

Among those appearing before the committee were Gene Buck, president of the American society, Victor Herbert, vice-president; E. C. Mills, chairman of the society's administrative committee; Ellis Parker Butler, president of the Authors' league; Augustus Thomas, and Nathan Burkan, attorney for the composers' society.

### Buck Tells of Legal War Chest

Mr. Buck made an attempt to refute the testimony given to the committee previously by the National Association of Broadcasters and referred particularly to the so-called "war chests" of his society which he said was for the prevention of adversity. He told something of the organization and its work and stated that both he and the society have a "great regard" for Radio. He told the committee that he was appearing in opposition to the Dill bill "for the life of song writing." He flatly denied that the American society and its allied interests form a monopoly or trust of any kind.

Questioned by members of the committee, Mr. Buck said that the American Society in asking broadcasters to pay for using songs does not differentiate between a station operated by Radio manufacturers or a station operated by a newspaper. He contended that when the public hears a song over the Radio they do not care to buy that song, and he said that the continual broadcasting of a song makes "the people sick of it." He did not explain why this was alleged to be true.

### Mills "Looks Forward" to Listener Tax

E. C. Mills of the American society, explained to the committee the "rights" in using copyrights. He said that no well-balanced broadcasting program can be made up of songs by one publisher or composer. He said that Radio "advertises songs to death." Mr. Mills said that he looked forward to the time when listeners in will have to pay a fee for their amusement and he told the committee that in his estimation Radio is an unfair competitor of every form of amusement.

Mr. Mills also told the committee that he does not think it will be long before the broadcasters of this country will have to pay all of the entertainers.

### Butler Would Postpone Action

Ellis Parker Butler, on behalf of the Authors' league, told the committee that he did not think the Dill bill should be considered for five or ten years, because of the newness of Radio art. He said that in his estimation the bill is a step backwards.

Augustus Thomas, playwright, told the committee that Radio is eating into the proceeds of the legitimate stage. He said that he believes the bill is unconstitutional and unwise and he expressed the hope that it would not be passed by Congress.

Nathan Burkan, attorney for the American society, went into considerable detail on the legal phase of the bill and discussed the formation of the alleged trust. He contended that Congress intentionally gave a monopoly to song writers and authors through the copyright law.

### Tuttle Rebuttal Wins Favor

At the second day's hearing among those appearing were Nathan Burkan, for the Composers' association; Charles Butler, of the Authors' league; Frank A. K. Boland, of the American Hotel association; Sidney S. Cohen, president of the Motion Picture Owners' Association of America; and Charles H. Tuttle, in rebuttal on behalf of the National Association of Broadcasters.

Mr. Tuttle in his rebuttal stated that in his estimation "Radio is the greatest blessing that science has ever given to man." He took up in considerable detail statements made by the Composers' association and in most instances riddled their case. He called particular attention to the fact that the composers are anxious to "pass the buck" to the listener-in, but he said, they failed to show the broadcasters how this was possible, even if they desired to do it.

### Music Publisher, Not Writer, Against Bill

He asserted that the composers want the broadcasters to join with them in an agreement to charge the public, in which case it would be one of the greatest monopolies ever realized. He denied that Radio is emptying the moving picture houses of America. He told the committee that it is the composers of the country who are trying to tax the Radiophans, and

# Dill Thinks Radio Tax Is Doomed to Defeat

## Senate Finance Committee Reports Tax without Comment

WASHINGTON, D. C.—Despite great public opposition, the Senate finance committee in reporting out the ten per cent Radio tax, dismissed the matter without comment as follows:

"A tax of ten per cent has been imposed on Radio receiving sets, and parts and accessories for receiving sets."

Senator Dill of Washington, one of the most ardent Radiophans in the upper house of Congress, states that he does not believe that the ten per cent tax as proposed by the Senate finance committee will become law.

Senator Dill says that this is the first time of which he has any knowledge that the Congress of the United States has started taxing any new industry when it was in its infancy.

not the writers of the songs, and he said that the American society is trying to tax Radio broadcasters and not the individual songs which it sends out. He called the committee's particular attention to the fact that it is the music publisher who is opposing the bill, and not the writers and authors.

During the course of the second day's hearings Nathan Burkan, on behalf of the American society, referred to the broadcasters as "organized pirates," but declared that the "composers" are not monopolists.

Mr. Boland, on behalf of the hotel owners, said that the society has commandeered all of the worth-while music there is. He said that Radio is making new writers and new songs.

Mr. Cohen, on behalf of the motion picture people, said that the American society is making use of the present copyright law as a blackjack.

# AMERICAN SOCIETY HOLDS UP VANITIES

## But Earl Carroll's Show Goes on KYW Midnight Revue in Part Anyway

CHICAGO.—Despite violent, last-minute efforts to carry out the broadcasting of the first act of Earl Carroll's "Vanities" from Station KYW, Westinghouse plant here, Mr. Carroll was forced to abandon his well-laid plans, advertised and announced by publications and Radio.

It was the original intention to broadcast the whole of the first act direct from the Colonial theater on the second night of the show. However, the American Society of Composers, Authors and Publishers, watching "their" interests, warned Mr. Carroll, in a battle of telegrams, that he must refrain from so doing. Station KYW announced the indefinite postponement of the enterprise.

However, Radiophans did receive a part of what was promised on the Friday night following (last week) when the entire cast of "Vanities" gave the midnight revue from KYW. Mr. Carroll is president of the song writers' branch of the American society.

## Women Fans Exchange Pet Cooking Recipes by Radio

DAVENPORT, IA.—One of the daily features at The Palmer School station here, WOC, is the woman's exchange of household hints, broadcast at 10 a. m., Central time, by Announcer GWW. The service started several months ago with semi-weekly bulletins from the bureau of home economics at Washington. Soon listeners began to submit their favorite recipes to be passed on to the rest of the big Radio family. Now it has become a real task to group the recipes and select the ones most suitable for broadcasting.

# CONTENTS

Radio Digest, Illustrated, Volume IX, Number 4, published Chicago, Illinois, May 3, 1924. Published weekly by Radio Digest Publishing Company, 510 North Dearborn Street, Chicago, Illinois. Subscription rates, yearly, Five Dollars; Foreign Postage One Dollar additional; single copies Ten Cents. Entered as second-class matter at the postoffice at Chicago, Illinois, under the Act of March 3, 1879.

All the Live News of Radio.....	1 to 10
Before They Thought of Mikes.....	5
Operating and Trouble Shooting for the Owner of a Howard Neutrodyne Receiver.....	11
What's Wrong with Your Receiving Set, Chapter X—Adjusting or Balancing the Neutrodyne Circuits, by Peter J. M. Clute.....	13
An Evening at Home with the Listener-In, a chart to show when to listen in for your favorite stations.....	14
Advance Programs for the Current Week at the Larger Stations.....	15 to 18
Thirty-Minute A-B-C Lessons for Radio Beginners, Chapter VII—Essentials of Radio Electricity, by P. E. Edelman.....	19
Editorials; Indi-Gest; Condensed by Dielectric.....	20
How to Construct a Super-Heterodyne Receiver, Part I—A Short Comment on I's Troubles, by Allan C. Forbes.....	21
Regeneration Sets Do Not Steal Signal Strength, Scientists Suggest that Sun's Dust May Be Cause, by M. W. Thompson.....	23
Old Stand-by Short Wave Regenerative Hook-up, Part I—Layout of Parts and Panel, by Major R. C. Schoonhoven.....	25
New Home-made Spider Web Mounting, Primary Coil Is Tapped for Selective Tuning.....	27
Simplex Hook-Up for Long Distance Reception on Single Tube.....	28
Two Forms of Loop Aerials and How to Make Them, Constructional Details and Parts Required.....	29
Questions and Answers.....	30
Directory of Radiophone Broadcasting Stations, Part I.....	31
Radio Illustrated, a page of pictures.....	32

# Looking Ahead

**Automobiling Pleasure Can Be Made Much Greater** by the simple addition of a good portable Radio Receiver. Next week H. J. Marx will show you how to install a practical antenna in your auto top. Later he will take up the efficient installation of sets in various manufactures of motor cars. Naturally he will begin with a well-known, low-priced car made in Detroit.

**Tuning the Neutrodyne Is a Trick Every Neutrodyne Owner Must Learn**—So Peter J. M. Clute will devote his time next issue to instructions in the proper method of handling this problem. Tuning of this receiver is different from many. Learn from Mr. Clute.

**Super-Heterodyne Panel Layout and List of Parts**—Allan C. Forbes will continue his interesting and instructive article on how to construct a super-heterodyne receiver. His "Rolls-Royce" of Radio is well worth building. It works perfectly.

**The Key to Radio Circuits will be given Radiophans** by Paul E. Edelman next issue. In his clear and understandable way, Mr. Edelman shows just what occurs in Radio hook-ups. Well-drawn analogies help to trace the current flow.

**Programs in Advance for Every High Power Station**—Sixty-four broadcasters list their other delicacies every week in Radio Digest, so Radiophans can know when and where they can hear their favorite type of entertainment or service.

Newsstands Don't Always Have One Left

WHEN YOU WANT

# Radio Digest

YOU WANT IT!

BE SURE OF YOUR WEEKLY COPY BY SUBSCRIBING NOW

SEND IN THE BLANK TODAY

Publisher Radio Digest,  
510 N. Dearborn St.,  
Chicago, Illinois.

Please find enclosed check M. O. for Five Dollars (Six, Foreign) for One Year's Subscription to Radio Digest, Illustrated.

Name .....

Address .....

City..... State.....

# Date for R. C. A. Hearing Not Announced as Yet

## Probably Will Begin Some Time Early in June

WASHINGTON, D. C.—The Federal Trade commission has not yet announced the date on which it will begin hearings in its case against the Radio Corporation of America and members in connection with the alleged monopoly. If the regular routine of the commission is carried out, however, it is probable that these hearings will be begun some time in June.

# SOUND FROM STARLIGHT

(Continued from page 1)

In collaboration with Commandant René Mesny, already well known for his successful work in Radiophony with waves less than two meters long, and with Monsieur Jouast, General Ferrié has succeeded in nothing less than the transformation of light rays into audible sound.

The importance of this discovery in general science, as well as in Radio, is so great that it has not yet been visualized clearly even by the scientists most closely associated with the experiments.

### Use Four Electrode Tubes to Amplify

The reaction of light on selenium cells is already well known to amateur scientists, that is, that light on these photoelectric cells produces a very feeble current. It is this current which the general and his colleagues have managed to amplify to a great extent, using for their work vacuum tubes of four electrodes. These tubes are capable of receiving a potential much higher than the ordinary three electrode tube of Radio.

### Hear Distant Star "Capella"

Experiments were made at the Paris observatory, using the light of one of the farther distant stars, Capella, and getting a variation of current of 3.5 microamperes. By charging a small condenser for ten seconds, by means of the electric current of the photoelectric cells, and then discharging this condenser into the vacuum tube, a decided amplification is obtained. When the number of discharges is brought up to ten or fifteen a second, oscillations are obtained which actually can be heard. Listeners in can now hear the hitherto "silent march of the worlds."

Further comprehensive experiments are now being made by Commandant Mesny.



# 50¢ AT YOUR DEALER WALNART TUBE SOCKETS

Adopted by leading radio set manufacturers. Dependable in all circuits.

Can be mounted on panel or base board (packed complete with mounting screws).

Electrically Right Strongly Constructed (Non-breakable) Perfectly Insulated Thruout Fits Into Small Space

Continental White Horn Fibre—the positive dielectric insulation is used in these sockets

Ask to see the Walnart Line of Quality Radi. Products Send for illustrated folder complete line Jobbers—Dealers—Manufacturers Write for Discounts

WALNART ELECTRIC MFG. CO Dept. 453 1249 W. Van Buren St., Chicago



# PARIS WOULD REACH U. S. ON 96 METERS

## YANK FAN TO ATTEMPT FEAT SECOND TIME

Reginald Gouraud Tried It in March But Forgot to Warn America to Be on Watch

By Frederick M. Delano

PARIS.—Reginald Gouraud, the young American Radio constructor here, whose famous exploit of interrupting the Eiffel Tower concerts in the spring of 1923 is still being talked of, has tried recently to make his fellow-countrymen listen to him. He had built, about six months ago, a small broadcasting set for commercial purposes. On the night of March 14, at 11:30 o'clock, he invited the American ambassador, Myron T. Herrick, to try to transmit a message to America—on 96 meters!

The ambassador very kindly consented to stay up that late, and at the appointed hour called into the microphone "Hello, Uncle Sam! Madelon presents her compliments to you, and expresses her affection for you."

### Forgot to Tell American Listeners

He then went on to make a few reassuring remarks about the serious condition of the French franc, after which Gouraud also talked for a few minutes, and then signed off, both in French and English—"Post 8DZ—Ici Poste Huit DZ."

The only hitch in the program seems to be that the young American forgot to advise any of his countrymen to listen for him at the right time (about 6:30 Eastern time). The results of his trials are therefore rather doubtful, but he is going to try again, giving plenty of warning first.

Gouraud's former license number, 8CA, was taken away from him for interfering with the aviation work. The new call letters, 8DZ, are those of his company, The Radio Union.

### Cop on Beat Tunes in

Very few American "cops" are apt to leave their beats to listen to an opera or classical concert. It might be safe to furnish them with Radio receiving apparatus, but in Paris it is an actual disadvantage.

One policeman was found here leaning against a bronze statue in the Luxembourg gardens, with a peculiarly wrapt expression on his face. Questioning brought forth the fact that he had a small portable Radio set.

"It is simple," he explained to the reporter. "This little set is for the pocket. In the street you simply hook one wire on to the street gas lamp and let the other rest in the gutter; and you can listen in on any local concert."

"But, ah—there—listen to that!" As the reporter turned away the "cop" was once again deep in apparent meditation, oblivious to the roaring traffic around him—listening to "Lakmé" as it floated from the Eiffel Tower studio through the teeming streets of Paris.

## Data to Show Effect of Broadcasting on Movies

### "Hollywood" McCosker at WOR Claims Pictures Not Hurt

NEWARK, N. J.—"Hollywood" McCosker, continuing his series "Current Motion Pictures", a weekly review of the new films from WOR on Monday evenings, is compiling considerable data from listeners on Radio and its effect on the movies.

Considerable competition has sprung up between the two forms of amusement, it is claimed, and Mr. McCosker, who does not believe that broadcasting is a menace to the motion picture business, has undertaken to prove his contention by securing letters from Radio enthusiasts stating just how the advent of the broadcasting has affected their attendance at the motion picture houses.

## RADIO AS LURE FOR VOLUNTEER LADDIES

BRIDGEPORT, O.—Citizens here are planning to use Radio as a lure to keep members of the volunteer fire department within the call of headquarters. A subscription paper has been circulated and money pledged for the purchase of a receiver. Donors believe that, with a Radio set in operation more of the firemen will loaf about the firemen's club rooms, resulting in greater speed in arrival at fires.

## ENGLISH FIRM NOW INSURES RECEIVERS

LONDON.—The insurance salesman now has a chance to take on one more branch of work about which to be "kidded." An insurance company here, struck by the number of Radio sets installed among its clients, has issued a new "Radio policy"; not against lightning in time of storm, but against theft, fire, and even a general deterioration from short circuits or any wrong adjustments.

## D.A.R. GOES ON WCAP AND WEAFF



Mrs. Anthony Wayne Cook, president general of the Daughters of the American Revolution, as she addressed the opening session of the thirty-third congress of the body in Memorial Continental hall, Washington, D. C. President Coolidge, Sir Esme Howard, Ambassador Jusserand and Secretary of State Hughes also talked at the first day's meeting which was broadcast by Stations WCAP and WEAFF. © Miller Service

## Billy Sunday Uses Radio in Huge Memphis Revival

MEMPHIS, TENN.—Rev. W. A. (Billy) Sunday delivered an address recently from WMC, Commercial Appeal station here. Reverend Sunday is conducting a huge revival in this city and broadcast a special sermon from WMC.

## Work on Senate Broadcasts

WASHINGTON, D. C.—The resolution introduced some time ago in the Senate by Senator Howell of Nebraska, which called for a survey of the Senate Chamber to be made by army and navy engineers with an idea of broadcasting proceedings of the Upper House, has been referred to the secretaries of war and navy.

## ROLL PEAS THROUGH TUBE FOR WGY RAIN

### MATCH STICKS AND TORCH FOR FOREST FIRE

Schenectady Station Evolves Novel Means of Producing Sound Effects for Dramas

By W. T. Meenan

SCHENECTADY, N. Y.—Did you know that the realistic rain effect you heard from WGY, the General Electric broadcasting station here, during the production of "The Fortune Hunter" was caused by the rolling of dried peas through a tube?

Would it have detracted from your enjoyment of "The Storm" to have known that the forest fire was produced by means of a plumber's gas oil-candle torch, the breaking of match stick and the crushing of paper? The torch produced the effect of rushing wind and flame, and matches and paper, brought close to the microphone, sounded like the crackling of burning tree limbs.

### Radio Drama Depends on Sounds

Successful transmission of a dramatic production by Radio is dependent upon sound properties. Atmosphere is created and action is simulated by sound, the devices varying with the needs of a particular production.

At WGY, where the Radio drama has been a popular weekly feature since August, 1922, special pains are being taken in the preparation of a play for the air to see that maximum sound results are obtained. Considerable experimenting is frequently necessary to produce the sound desired.

Two of the most frequently used sound properties of WGY are the door and the bell board. The bell board consists of a convenient arrangement of five bells of different tones and a buzzer. All are connected to dry cells and may be operated by the pressure of a button. There are door bell, telephone bell, an alarm bell which may be sounded for fire, ambulance or as a burglar alarm. A clock chime is in the group, as is a tap bell.

### Portable Door Announces Exits

Probably no property is more important than the portable door and door frame, for it is only by the closing of the door, in interior scenes, that the entrance or the exit of a character may be conveyed to the Radio listener.

The door is one of the peculiar conventions of the Radio drama. Whereas in the home a softly closing door is considered desirable, it is quite important in the Radio drama that the sound of the door and clicking of the lock be loud enough to actuate the microphone. The WGY door is made of thin oak and has a peculiar resonant quality and is easily recognized as a door by its sound.

## HOLDS FARMER GETS MOST RADIO BENEFIT

### University Leader Points to Advantages of Entertainment

DETROIT.—Prof. H. H. Musselman, head of the Michigan Agricultural college engineering department, declares that his institution is making a special effort still further to interest farmers and others in the country districts in the possibilities of Radio.

"Radio," says Prof. Musselman, "is really of more benefit to the farmer and others in the rural districts than to the man or woman who lives in the city, because the farmer doesn't have the opportunities to go to concerts or enjoy other means of entertainment as do those in the thickly populated centers. Again, Radio is especially well adapted to the farm because little interference is experienced from neighbors' outfits, good locations for aeriads are many, and not a very expensive set is required."

## THE ANTENNA BROTHERS

### Spir L. and Lew P.

## A Bargain at Half the Price

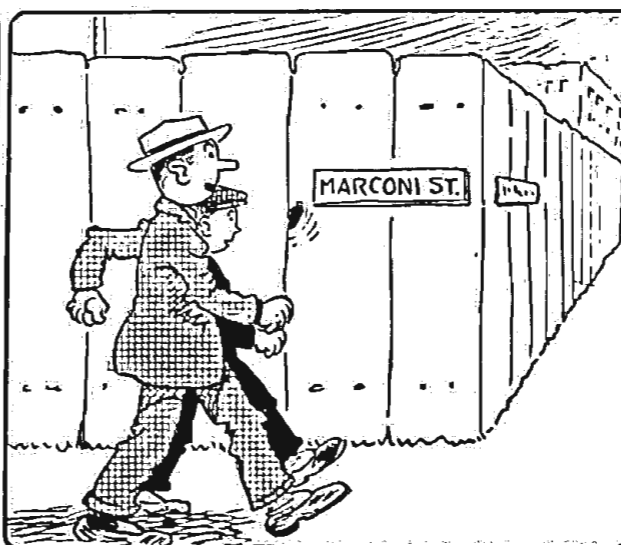
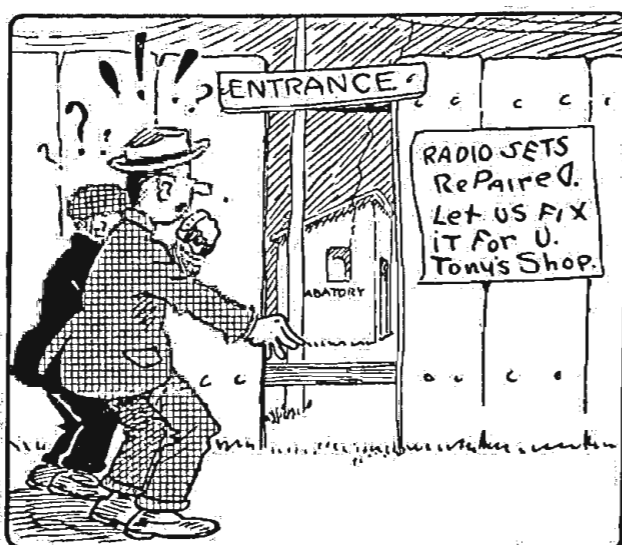
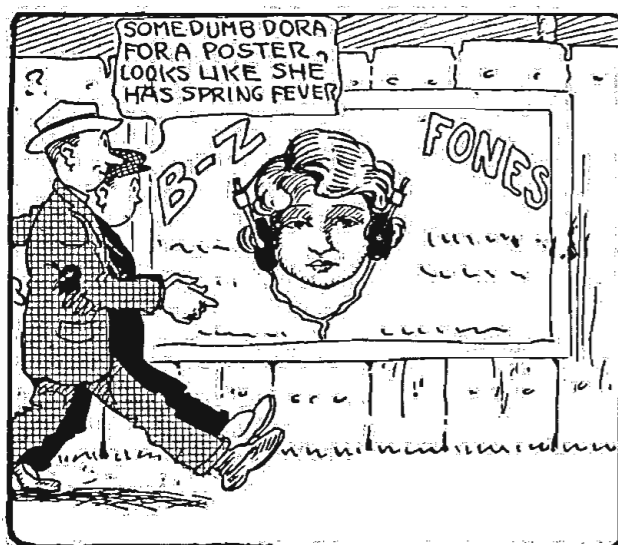



THE AIR IS FULL OF THINGS YOU SHOULDN'T MISS



# Get ready now for summer radio

YOUR radio batteries have served you well and faithfully over the long winter months. Now a great radio summer is at hand. To enjoy summer radio at its best, equip your receiver with the best batteries you can get. Put in new Eveready Radio "B" Batteries and see what wonderful, long-lived service they will give.

Made especially for radio use, Eveready "B" Batteries will operate the loud speaker at maximum volume for long or short periods, depending on how rapidly the current is taken out of them. Packed full of pep and punch and go, Eveready "B" Batteries pour out their power the moment you turn on the tubes. Scientifically made for long-lived radio service, the cells renew their vitality when idle—responding instantly with fresh vigor.

Eveready "B" No. 767 is the standard amplifier "B" Battery, and gives 45 powerful, dependable, zippy volts. Five sturdy Fahnestock Clips make this big "B" Battery available for soft detector tube use as well—varying the voltage from 16½ to 22½ as required.

Insist on Eveready "B" Batteries, remembering that they are the product of thirty years of experience and know-how in battery making. Designed and made under the supervision of the finest electro-chemical laboratory known to science, the quality and efficiency of Eveready Radio Batteries are assured. For maximum battery economy and service buy Eveready Radio Batteries—they last longer.

Manufactured and guaranteed by  
NATIONAL CARBON COMPANY, INC., New York—San Francisco  
Headquarters for Radio Battery Information  
Canadian National Carbon Co., Limited, Toronto, Ontario

Informative and money-saving booklets on radio batteries sent free on request. If you have any questions regarding radio batteries, write to G. C. Furness, Manager, Radio Division, National Carbon Company, Inc., Thompson Ave. and Orton St., Long Island City, N.Y.

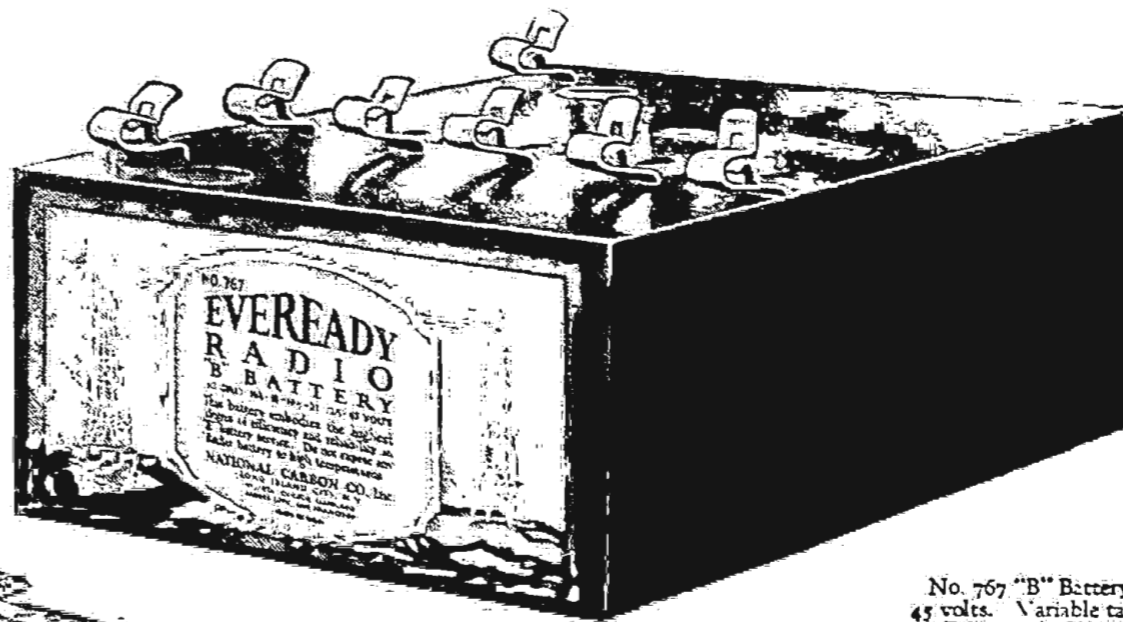

No. 767 "B" Battery  
45 volts. Variable taps  
Fahnestock Clips

No. 766 "B" Battery, 22½  
volts. Six Fahnestock  
Spring Clip Connectors

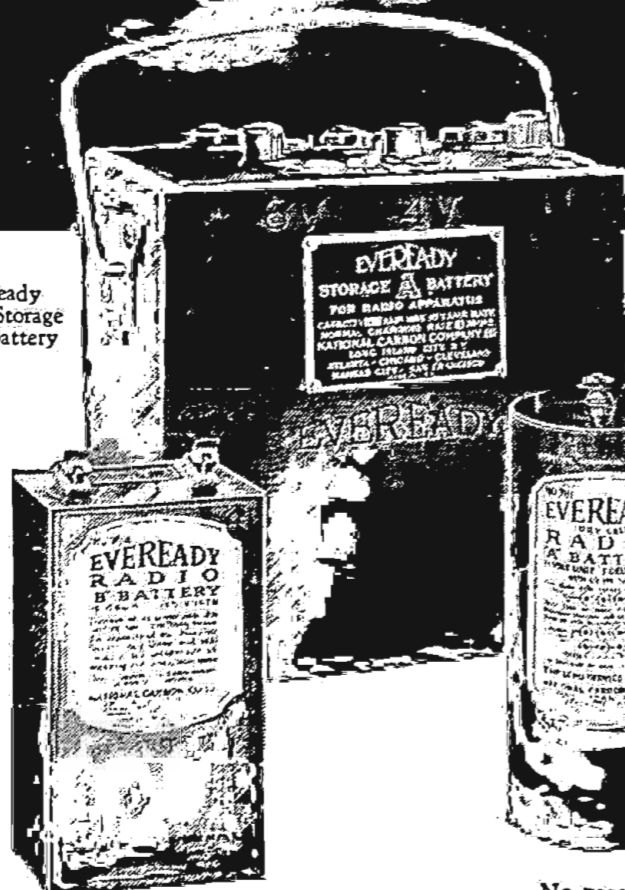

Eveready  
6 volt Storage  
"A" Battery

No. 764. The Space  
Saver. Vertical 22½  
volt "B" Battery

No. 7111  
Eveready Radio "A"  
Dry Cell. The best  
battery for use with  
dry cell tubes



No. 771 "C"  
Battery. Clarifies  
tone and prolongs  
"B" Battery life

# EVEREADY Radio Batteries

—they last longer



# BEFORE THEY THOUGHT OF "MIKES"



Robert Van Cleve, WHK, is the little curly headed fellow shown last week, while the little tot dressed in all the ruffles is represented by the gent at the right, Robert S. Whitney, WMAQ's popular announcer.



Little did this 3-year-old realize that when 25 years more of his life had been spent, he would be dispensing fun over the ether as announcer for WD—. From the photo one would think he was destined to be another Napoleon or perhaps a silk salesman.

This little mite, since this picture was taken, has had wide concert and vaudeville experience as a vocalist and pianist and still he is one of the youngest announcers in America. Next week's issue will give more interesting details about this young man.

## WATERSON IN COURT FIGHT OVER RIGHTS

### ACTS AGAINST CHIEF OF COMPOSERS' SOCIETY

Also Seeks Writ to Stop Broadcasting of His Songs by Owners of WBS

NEW YORK.—Waterson, Berlin and Snyder company has instituted injunction, damage and accounting proceedings against Gene Buck as president of the American Society of Composers, Authors and Publishers, and D. W. May, Inc., owners of station WBS, Newark, N. J.

Henry Waterson, one of the first organizers of the American Society, recently resigned from the organization, alleging the defendant to be a monopolistic organization in violation of the Sherman anti-trust laws.

Waterson controls the Jack Nelson Music Co., a subsidiary music firm organized primarily to broadcast and take advantage of the ether song "plugging" system.

#### Waterson Does Well With Radio

The Waterson, Berlin and Snyder resignation was refused by the American Society, which holds the contract does not expire until January 1, 1926. Waterson organized a subsidiary organization, with the result "After the Storm" and "From One Two" are beginning to show as real hits through being plugged solely by Radio.

The lengthy legal complaint is highly interesting. The song "Maybe She'll Write Me, Maybe She'll Phone Me" is singled out as an instance for purposes of the test case.

D. W. May, Inc., is involved through having taken out a special license from the American Society for the privilege of broadcasting the general catalog controlled by the first-named defendant. Waterson would enjoin this corporation from further broadcasting his songs.

#### Suit May Give More Radio Music

A statement by C. B. Cooper, chairman of the broadcasting committee of the Radio Trade Association, New York, says: "Contrary to articles in many newspapers, this suit is not being brought for the purpose of stopping broadcasting stations from using popular music, but if won it will give more popular music of more publishers to more broadcasters than ever before."

"The Waterson, Berlin and Snyder company is anxious to have their music played by as many broadcasters as possible. The stations not in the American Society tax list are by far in the majority. When this case is finally decided, if the Waterson, Berlin and Snyder company gets a victory, there will be a great deal more popular music broadcast from Radio stations than ever before."

Throughout the United States there are 3,000 manufacturers of Radio supplies, 1,000 wholesale distributors and jobbers and 25,000 retail dealers of all kinds.

**Robert VanCleeve, WHK**  
ROBERT VanCleeve is this gentleman's full name, but as he is never full, he is much better known as "Van". While nominally operator at WHK, Mr. VanCleeve appears before the microphone with sufficient regularity to entitle him to honorable mention as an announcer.

How he gets before the microphone no one knows, but his friends seem to take quite an interest in him so they must be to blame.

"Van" says he doesn't remember when he was not interested in Radio. Back in 1908 he was a ham operator—accent on the ham—and kept up the good work until, during the war, he qualified as inspector of Radio equipment in the naval service, dividing his time between Cape May, League Island, and other eastern points.

They do say that "Van" has an eagle eye for trouble, but it is only grief of technical Radio nature he is after, being very mild-mannered and soft of speech. He is usually before the microphone at WHK's Friday night concerts and also makes selections of the musical reproductions broadcast from that station during the afternoon programs.

"Van" gets more than his share of letters from the ladies, but said letters are as sweetness wasted on the desert air, for "Van" is married.

## Portable Amplifiers Interest Politicians

### Senator Attracted by Test of New Auto Truck Device

WASHINGTON, D. C.—Senators and Representatives who have campaigning to do, the coming fall showed much interest recently in the demonstration of amplification for public addresses, given just outside of the Capitol using specially equipped automobile trucks.

Two trucks were used in the demonstration, the larger being adaptable to any size audience, and the smaller to a more limited audience, such as might gather within the limits of a city block. The automobiles were equipped with vacuum tube amplifiers, batteries and a group of horns mounted on telescopic masts fixed to the truck. These were fifteen and twenty-five feet high respectively, the higher mast being used on the more extended system.

The tail boards of the trucks when lowered formed the speaker's platform, including a stand and railing and steps to mount. A microphone was attached to the speaker's stand.

## Isolated Southland Hears Ministers of Big Cities

NASHVILLE, TENN.—With the going on the air of WCBQ, a 100-watt station owned and operated by the First Baptist Church of Nashville, religion in the southland has acquired a particularly facile means of delivering to isolated districts that religious eloquence possessed by ministers of the large churches of Nashville.

The station was financed by the Business Men's club of the First Baptist church and was formally presented to the church at a recent morning service.

**Robert S. Whitney, WMAQ**  
A HOWLING success, that was the future picked for Robert S. Whitney by his parents and friends upon his arrival into this world, at Newcastle on Tyne, England, quite a few years ago.

His friends said that they were not sure of the success part of it, but, he certainly could howl. A very close friend (no, not a Scotchman), admitted that the Captain on the ship "Bob" came over on, wanted to borrow him one day for a fog horn.

Mr. Whitney received his schooling in Chicago, and although we searched the school records, no trace was found of where he out-talked the teacher. Among the things Robert studied, was music.

He is an accomplished pianist and composer. What songs he has composed we are unable to say, but, when it comes to playing the piano, he clutches a mean bunch of ivory.

Besides doing all these little things, he is the star announcer at Station WMAQ. Did you ever listen to the golden voice that warbles through the ether, and tells you what is next on the program? Well, that is the young man himself. A decided bachelor. When he decided is unknown, but he IS a bachelor.

The two things he does exceptionally well are eating and sleeping. In fact these are his hobbies. The reporter who interviewed Mr. Whitney challenged him to an eating race, which will be broadcast from WMAQ shortly. Listen in for it, and you'll hear how nice mannered they both are.

## JAP FAN PICKS UP WOR'S ESPERANTO

### Tokio Listener Also Hears Dinner Hour Musical Selections from Newark

NEWARK, N. J.—Owners, managers and operators of Station WOR here, are jubilant over the new record established by that station the evening of April 6 when its signals were heard by Hiroshi Ando, famous Japanese Radio engineer, in his home at Tokio.

At 6:15 p. m., Eastern time, a speech was made in Esperanto by James Sayers, Esperanto being the proposed international language which world-wide Radio makes necessary. Mr. Ando had been listening since 5 o'clock the morning of April 6 which was 3 o'clock the day before in Newark. When their dinner hour program began he heard, very faintly, the musical selections, then the announcement and then clearly, the talk in Esperanto which he is familiar.

Joseph M. Barnett, manager of WOR, was delighted. "We were heard in Japan the night of December 15," said Barnett, "when we put on Paul Whiteman at 4 o'clock in the morning, but that was a special effort. This latest record is a real achievement since it was made with our regular program."

# Your Choice FREE Limited Supply

Your prompt action gives you one bound volume with each annual subscription. New or renewal.

Greatest Collection of Radio Information  
A. B. C. Lessons for Radio Beginners.  
Two, Three, and Four Tube Reflex Circuits.  
The Famous Miloplex with Various Hook-ups.  
Reinartz Long Distance Circuits—Ultra Reinartz.  
Flewellling Popular "Flivver" Circuit.  
Single Tube Reflex Circuits—Super-Heterodyne.  
Five Tube Neutrodyne, Special R. D. Hook-ups.

In addition to these features, the current issues give you all the live news in Radio. The popular Q. and A. Department. How to Operate Your Set, Advance Broadcasting Station Programs, and a correct list of all Broadcasting Stations.



# 65 Copies

Serving as a Radio Reference Library  
You receive 52 issues with your Subscription and 13 issues in each bound volume

Bound Volumes 3, 4, 5 and 7 now ready.

This offer good only in U. S. and Possessions, and Canada.  
This offer not good through dealers or subscription agencies, but must be sent us direct with the full subscription price. Remittance must be by check, money order or draft.

RADIO DIGEST, 510 N. Dearborn St., Chicago  
Check Offer Desired  
 One year's subscription, and choice of one volume. Send Vol. .... Enclo. .... \$5.00  
 One year's subscription, and choice of two volumes. Send Vols. .... Enclo. .... 7.00  
Additional Bound Volumes at \$2.00 each.  
Name .....  
Address .....  
City ..... State ..... 5-3-24



# FACTIONS CLASH ON RELAY CHIEF VOTES

## CENTRAL DIVISION VOTING AROUSES PROTESTS

Backers of Milwaukee Candidate Demand Third Ballot: Contend Error in Name

DETROIT.—Members of the Central Division of the American Radio Relay League have recently been called upon to elect a new director to represent them at the headquarters of the league. There have been four candidates for this office, chief among them being Clyde E. Darr, present assistant division manager of the league in the state of Michigan and a member of the board of direction for several years as well as an active Radio man. The Milwaukee Amateur's Radio Club of Milwaukee, Wis., have been diligently pushing the candidacy of one of their own members, C. N. Crapo of Milwaukee, a comparative newcomer in the amateur field, but whose advisers are apparently fully aware of all of the tricks of the political game.

### Milwaukee Man's Name in Error

The elections of the league are made through sealed ballots sent to each member by mail. Complaint has been recently lodged with the headquarters of the league, immediately following the announced results of the election, which showed Darr an overwhelming victor, to the effect that the vote should be thrown out and a new ballot sent out because of the fact that the Milwaukee candidate's name was not properly entered on the ballot. In accordance with this complaint the officers of the league at Hartford, Conn., decided to send out a second ballot, and this accordingly was done, a notice being put at the top of the ballot explaining the reason why it was sent out.

It has now come to light that the majority of the members of the league in this division assumed that the second ballot was sent them by mistake, and since they voted on the first one have discarded the second without voting. The Milwaukee contingent, however, voted 100 per cent for their candidate.

### To Take Third Ballot Now

Due to the watchfulness of the Darr campaign managers, the "attempt" has been frustrated and an appeal lodged with the officers of the league requesting a

# WLW DIRECTOR NOW HUSBAND



THE culmination of a Radio romance was the marriage recently at the Walnut Hill Presbyterian church, Cincinnati, of Miss Marjorie Garrigus, of Kokomo, Indiana, a piano student at the Cincinnati Conservatory of Music, and Fred Smith, studio director and announcer at Station WLW. The ceremony was performed by the Rev. Frederick N. McMillin, known as the Radio pastor, being the first minister in Cincinnati to broadcast his Sunday evening sermons regularly. Dr. McMillin recently performed a marriage ceremony by Radio.

Miss Garrigus frequently appeared on WLW programs as soloist and accompanying co-students and other performers and the romance had its beginning in the WLW studio. Mr. Smith was back on the air four hours after the wedding, but said nothing to his listeners about what had transpired since his last previous sign-off. Picture shows party on the steps of the

Walnut Hill Presbyterian church. From left to right, in front, are Alvin R. Plough, best man, Miss Susanna Moore, bridesmaid, Fred Smith, Mrs. Fred Smith, and Powel Crosley, Jr., who gave the bride away; second row, Rev. F. N. McMillin, George Lewis and Miss Louise Koetter.

Nitrogen-filled tubes have proven satisfactory for Radio use.

# ADAM'S RIB FAILS TO MAKE ITS MARK

Fan Just Couldn't See How It Was Used in First Loud Speaker

COLUMBUS, O.—"Boots" Carothers, an announcer for WBAV, Erner & Hopkins Co., recently told his listeners the joke about the first loud speaker having been made from Adam's rib. A few days later he received a letter from a fan asking him to repeat the story, as he didn't quite catch it. So Mr. Carothers announced, the following day, that he had been requested to repeat the story about Adam's rib being used to make the first loud speaker, but he didn't dare repeat it, as he had also received dire threats from various women for telling it the first time. Then came the letter that capped the climax. A fan wrote:

"Since you can't repeat the story about using Adam's rib to make the first loud speaker, will you please write it and mail it to me in the enclosed stamped envelope? If it's as good as it starts, it must be a hum-dinger."

third ballot after a complete explanation of the circumstances to the membership.

The Darr campaign managers intimate that it is extremely probable that the Milwaukee candidate's name was printed on the original ballot erroneously with the idea in view of working the plan out exactly as has been attempted. That this may be true is indicated by the fact that each candidate himself supplied the information regarding his qualifications, etc., which was printed on the original ballot.

If it is true such tactics are being used by the Milwaukee candidate, Darr will undoubtedly be returned an even more overwhelming victor on the third ballot, which will be held after due notice of the circumstances has been given the entire membership.

# Federal has done the experimenting for you

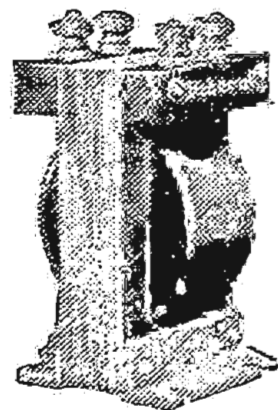

The now famous No. 65 Audio Frequency Transformer is but one of over 130 radio parts designed, manufactured and guaranteed by Federal.

**\$7.00**



The sign of Reliable Radio Dealers



# Federal

Standard RADIO Products

THERE is no speculation about buying Federal Standard Radio Parts. You know beforehand just how complete, just how mechanically perfect your set will be according to the number of Federal parts that are included.

Federal has done all the experimenting for you—not hurriedly or superficially, but over a period of 25 years of intensive research. This, together with Federal's tremendous engineering facilities, makes it possible for Federal to protect you with an iron-clad guarantee on every Federal Standard Radio Part that you buy.

FEDERAL TELEPHONE AND TELEGRAPH COMPANY

Factory: Buffalo, N. Y.

Boston New York Philadelphia Chicago San Francisco  
Pittsburgh Bridgeburg, Canada London, England

### Get This Book! "How to Build Neutrodyne Radio Receivers"

This 48-page book is the standard authority on making five-tube Neutrodyne receivers. Fully illustrated with picture wiring diagrams and a full-size drilling template for a five-tube receiver. Complete instructions on assembly, wiring, neutralizing and tuning. Also includes detailed trouble-shooting information. Sent post-paid anywhere in the U. S. for 50 cents. Write for this new edition today.



### FADAKnock-Down Parts for Five-Tube Neutrodyne Radio Receivers

165-A—Three Neutroformers and two Neutrodons with "How to Build It" book. The heart of the Neutrodyne receiver—\$25.00.

167-A—Everything for five-tube set down to last screw and binding post. Complete with book, panel, baseboard, sockets, telephone jacks, audio frequency transformers, Neutroformers, Neutrodons, etc.—\$65.60.

Ask your dealer for FADA parts.

# Make yourself a FADA Neutrodyne receiver and enjoy the best in radio

THOUSANDS and thousands of successful Neutrodyne receivers have been built by radiophans using only FADA Neutrodyne parts. With the famous FADA "How to Build It" book (over 150,000 of which have been sold) anyone can build a five-tube Neutrodyne receiver that will amaze by its fine performance.

FADA Neutrodyne receivers have made wonderful records for distance and volume, for selectivity and ease of operation. A resident of Forrest Hills, Long Island, writes, "Heard London and Glasgow on loud speaker evening of March 13th with FADA five-tube set."

Because the Neutroformers and Neutrodons require special engineering design, they are naturally the heart of the receiver. FADA parts are made accurately to scientifically correct specifications—they've got to be right and are right before they pass our rigid standards of inspection.

If you want to own the most satisfactory radio receiver, buy FADA Knock-Down parts and build yourself a five-tube Neutrodyne receiver. Dealers everywhere sell genuine FADA Neutrodyne parts—look for the name and trade-mark on every package.

F. A. D. ANDREA, INC.  
1581 Jerome Avenue, New York City



F. A. D. ANDREA, INC., 1581 Jerome Avenue, New York City  
Gentlemen: Enclosed find fifty cents {  Stamps } for which send me your book on "How to Build Neutrodyne Receivers." {  P. O. Order }  
Name.....  
Street Address or R. F. D.....  
City or Town..... State.....

# MATE OF MAGGIE IN EXPOSE OF HIMSELF

"MYSTERY MAN" ADMITS HIS IDENTITY

Milo Gurney in Expose When His Better Half Threatens to Quit Writing His Stuff

By the Mystery Man

Dear Editor:  
 Alright! Alright!  
 You said you'd make me famous—Maggie says you made me "notorious." Either is bad enough, but when a guy has just one little interview, why print it in the "Funeral Notices" column? You know what I mean—that column where they give a list of people who ain't going to patronize flower shops any more and leave this good old earth wondering whether there will be a scarcity of help in the place they are going to.

Then again—can't a dude have an interview without 6 or 700 of "my gang" immediately sending letters and telegrams daring me to publish my picture?

Maggie Demands Expose

Not that I care, but Maggie says, "You'll either expose me as no cook or I'll quit writing your stuff." Then another city feller writes in daring me to publish my picture and sends along enough soap coupons to buy a "puddle jumper" named Elizabeth and hopes it keeps me rattled. Now I don't like no dare—no time—if I've got to take the step I might as well make it a dozen even if 12,000 wives do tell their husbands the truth about my rare type of beauty.

Who's Who in Miloplex Kingdom

So here's the picture, the guy in the center is me, the lady is my sweetie, "Maggie," while the kid is the reason why some girl will write mash notes later on.

And, editor—be sure to print my name, "Milo Gurney," right under the picture in bold face type so the undertakers can see it, and then the words "The Mystery Man" right under it soaz to scare 'em.

And now, "Gang," you know who I am, how sweet Maggie is, and can you blame me for always wanting to eat when I have so nice a cook? Let's eat!

Cuba has thirty-one stations which broadcast Radio programs. There are eighteen stations in Havana.

## FAMOUS KINGDOM OF MILOPLEX



Curious readers have their curiosities satisfied this week—for the Mystery Man, inventor of the Miloplex series, whose writings have appeared for some months in this publication—divulges his true name, along with his family. Above, left to right, are Mrs. Milo Gurney, alias "Maggie"; Milo Gurney, alias "Mystery Man," and their son.

O. H. Huszagh Photo

## LISTENERS VOTE DOWN CAPITAL PUNISHMENT

Sing Sing Warden and Senator in Radio Debate

NEW YORK.—Debates on various important subjects with the Radio audience as the judge, seem to be quite the thing at our best broadcasting stations these days. Recently Station WEAJ broadcast a debate between Warden L. E. Lawes of Sing Sing and Senator Love of Brooklyn, the subject being the Abolition or Retention of Capital Punishment.

The debate attracted unusually wide attention and thousands of letters, expressing the views and opinions of interested listeners poured in. An analysis of these letters showed that 48 per cent. of the

audience favored capital punishment and 52 percent. were against. The Radio audience also voted on the question of who won the debate and the figures showed that 42 percent. felt that Senator Love presented the best argument, while 58 percent. were with Warden Lawes who presented the arguments against capital punishment.

## Communications Course Now Launched at Yale

NEW HAVEN, CONN.—One of the first lectures before the students of the Sheffield Scientific School in Yale's communications course, was on "Naval, National and International communications", delivered by Commander D. C. Bingham, U. S. N., assistant chief of Naval Communications, recently.

The lecture is one of a course estab-

## JANITOR SHOULD BE RADIO EXPERT NOW

NEW TASK BEFORE THIS JACK OF ALL TRADES

Apartment Families With Varied Tastes In Broadcasts Add to His Woes

By Carl H. Butman

WASHINGTON.—If bulldozers throughout the country continue to erect apartment houses and furnish tenants with Radio entertainment from a central receiving station, janitors will have to be able to operate receiving sets and handle complaints.

In Washington, several apartment owners object to numerous aerials of many different types which they claim disfigure the roofs. Other landlords, more thoughtful as to the comfort and happiness of tenants, are installing one aerial with a receiving set in the basement and running wires to plugs in each apartment so that occupants who desire may plug in phones or loud speakers.

Must Be Master Diplomat

This is fine, but can the owners find janitors capable of operating the sets to suit the listeners in? The Trotts are sure to want jazz from WHIZ when the Kirks desire sacred music while the minister is calling. Mrs. B. Serious insists on an oratorio from WHEE, at the same time Miss Flapper requests dance music. Willie Whistle calls for a Radio talk; Mrs. Dresser, fashions; Mr. First Cuffs, ringside gossip; and Mr. Liter Rary, current topics.

No ordinary janitor could hold the job a day, let alone a night, and one subject to bribes would soon be ready to retire. Only by keeping a request sheet for each hour of the day could he satisfy even a few of the many calls he will receive, with objections outnumbering requests.

lished by the electrical department, through the aid of Dr. Lee De Forest, for graduate and advance students.

Commander Bingham opened his talk with a Biblical reference to the days when "The whole earth was of one language and one speech", following with the story of the stopping of construction on the Tower of Babel, by the confusion of speech. This, he said, indicated that communication between individuals, as well as nations, was essential to any progress."

## BRISTOL SINGLE CONTROL RADIO RECEIVER

Using Grimes Inverse Duplex System  
 Patents Pending

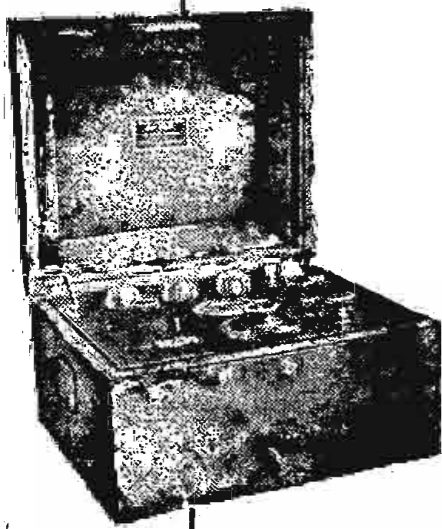

### Most Simple to Operate

The set for those who want results with little effort. Anyone in the family can quickly learn to operate it because technicalities and guesswork are eliminated—One Control Dial does it all.

### Does Not Interfere With Your Neighbor

Other close by reception is not disturbed when you tune in with this non-reradiating Receiving Set. It gives you a comfortable sensation of freedom to be able to change from one station to another knowing that you will not interfere with your neighbor's receiving.

### Choice of Aerial or Loop

Where conditions make it difficult to install an outside aerial, as in congested sections of cities, good results can usually be had by using inside Loop. In fact, the directional feature of the Loop often brings in stations not possible with a stationary aerial.

Mounted in solid mahogany case with walnut finish, the Bristol Single Control Radio Receiver is handsome in appearance. The price is \$190.00. Bulletin AY-3013 describing this set will be mailed on request.

## BRISTOL

TRADE MARK  
**AUDIOPHONE**  
 REG. U. S. PAT. OFFICE

## Loud Speaker

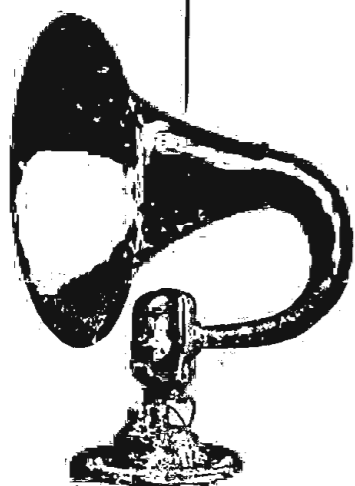

This is known everywhere as the Loud Speaker with the quality tone. Not only is the tone natural and without mechanical distortion, but is sufficiently big in volume to be easily heard in a large room or all through the house. Comes to you ready to use—no auxiliary batteries are required.

Made in three models:

- Audiophone Senior.....Price, \$30.00
- Audiophone Junior.....Price, 22.50
- Baby Audiophone.....Price, 12.50

THE BRISTOL COMPANY, Waterbury, Conn.

**The GREBE TANGENT WHEEL VERNIER**

Grebe Regenerative Receivers are licensed under Armstrong U.S. Pat. No. 1,113,149

—for "Hair's breadth" Dial adjustments

*A Device found only on GREBE Receivers*

THE man who has once operated a Grebe Receiver reaches instinctively for the Tangent Wheel Verniers on every other receiver he thereafter tunes.

This and other details of Grebe craftsmanship are fully covered by patents granted and pending. Inspect these details at your dealer's today.

*"The accomplishment of great things consists in doing small things well."  
 —Confucius*

Perfection of detail is a big factor in the success of the Grebe Receivers.

*Doctor Wm.*

**A. H. GREBE & Co., Inc.**

Richmond Hill, N.Y.



# Announcing—

the

# ST. JAMES

# Long Wave

# Transformer

—*in vacuum*

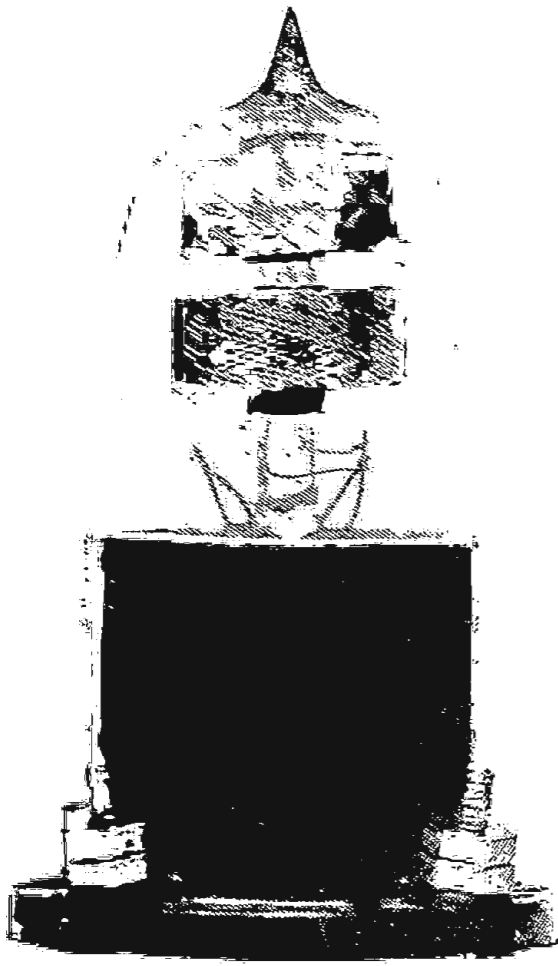

(Patent Applied For)

Seldom in the history of radio has a piece of apparatus been placed on the market which has attracted such favorable comment from the most discriminating experts. The results which have been consistently obtained from its use in the newer circuits demanding transformers of this type, have been so surprising that the baldest statement of them would sound like wild exaggeration.

Experimenters and transformer manufacturers have always recognized the advantages of the air core transformer for maximum amplification at a given wave length. In practice, it has heretofore been found impossible to construct transformers of this type which could be depended upon to give uniform and satisfactory results under all conditions.

The absorption of atmospheric moisture in untreated coils causes losses of the most serious character. Impregnation of the coils with gums or resins removes this difficulty but not only increases the inter coil capacity but also introduces absorption losses on account of the large amount of dielectric in the magnetic field of the coil.

The ST. JAMES Transformers not only overcome this condition but in addition, offer other advantages previously unthought of.

At first inspection it is evident that they represent precision methods of the highest character. The special wound coils

constituting the primary and secondary, are in themselves an achievement. These are accurately spaced on a glass rod, thoroughly dehydrated, enclosed in a tube of special high lead content glass which is thoroughly evacuated to a high degree of vacuum.

The leads are brought out to the terminals of a standard socket of bakelite in which the transformer is permanently mounted.

What is the result?

First, transformers permanently retaining the high efficiency characteristic of thoroughly dehydrated, unimpregnated, low loss coils.

Second, a very considerable increase in magnetic flux.

Third, losses too microscopic to be susceptible of measurement.

Fourth, sharply peaked and absolutely accurately matched.

Fifth, thoroughly shielded without eddy current losses due to the lead content glass.

It is true that these claims exceed those ever made for any similar transformer, yet they are the baldest possible statement of actual facts. The enthusiastic reception which has been accorded them presages an overwhelming demand. We cannot increase our production at this time above a certain point without lowering our standards which we are pledged to maintain under all conditions.

We strongly suggest that you take steps to secure your set at once. Ask your dealer first. If he has not yet received his supply and will not order them for you, we will for the time being only, supply you direct. Set of four include one input, three intermediate. Price, \$8.50 each. Orders for C. O. D. shipment must be accompanied by one-third of the total price.

**JOBBERS:** These are being selected with especial care. A proposition of unusual interest will be offered to concerns whose policies are such that they welcome careful scrutiny. Address:

## TED HATCH & STAFF

EXCLUSIVE DISTRIBUTORS

721 North Michigan Avenue, Chicago, Ill.

Manufactured by

St. James Laboratories, Chicago, Ill.



# NOW NEW PROBLEM CONFRONTS GOTHAM

## PUZZLES OVER DIVISION OF AIR AMONG STATIONS

### Settlement of WHN's Suit Brings Sudden Rush of Applications for Plant Licenses

NEW YORK.—The settlement of the "King Telephone" vs. WHN suit has brought an unexpected result here. Almost immediately there have come applications for the erection of at least half a dozen additional broadcasting plants. The applications range all the way from the city of New York itself down to a small department store.

The problem has arisen of providing practical wave lengths for all the proposed new stations. The representative here of the Department of Commerce wants at least four of the new broadcasting stations to take the same wave length, despite the fact that all are to be so close together.

This would mean, of course, that the four stations would have to arrange for an exact division of time, because no two of them could operate successfully at the same hour.

The suggestion that the city of New York should share a wave length with three other stations has aroused the city's board of aldermen.

How the situation will be met is a big problem for the under-appropriated Radio division of the Department of Commerce.

### London Hears U. S. Applaud Ambassador in New York

LONDON.—Members of the Pilgrim society, assembled at the Carlton Club, here, listened to the speeches and applause of a dinner given the new British ambassador to the United States, Sir Esme Howard, by the Pilgrim Society of New York at the Waldorf Astoria hotel recently. The banquet room in the New York hotel was wired to WJZ and WGY.

WGY was broadcasting a play on 380 meters so simultaneously sent out the Pilgrim dinner speeches on 107 meters. The short waves were successfully received here.

# JENKINS DEVICE BROADCASTS MOVIES LIKE MUSIC

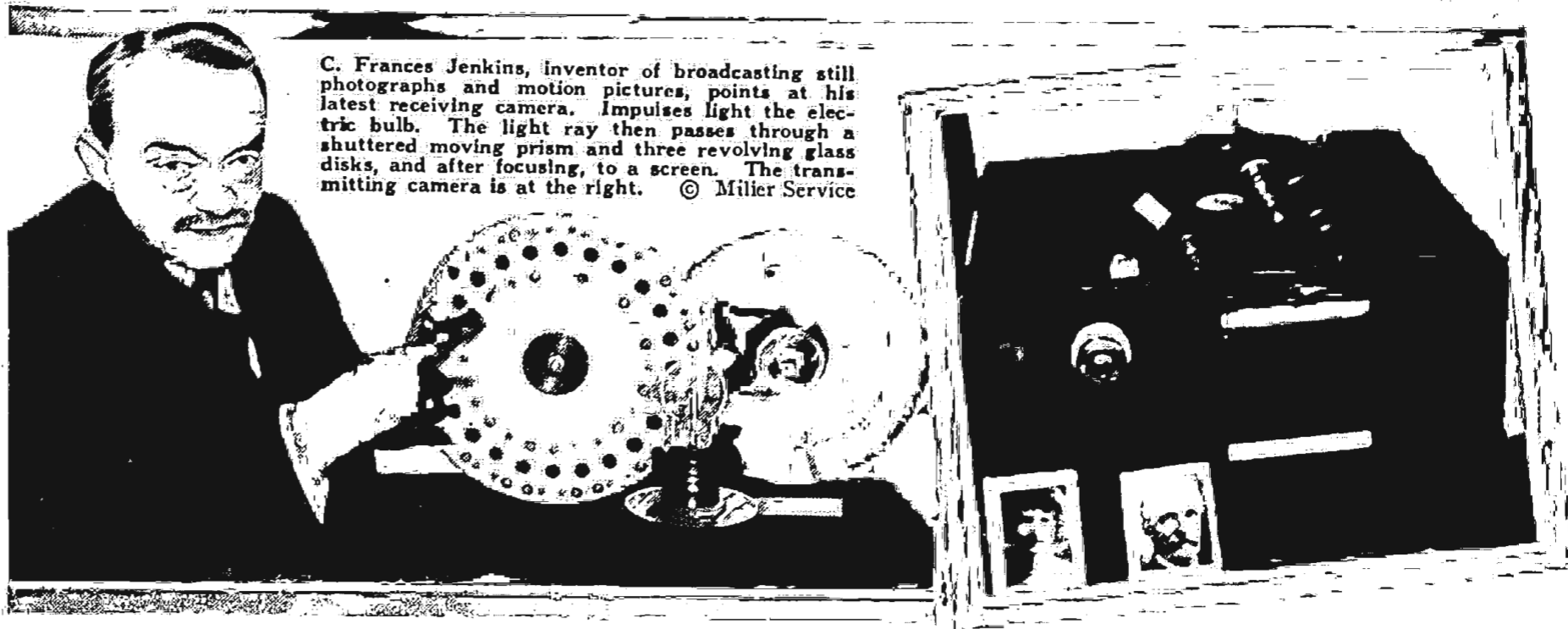

C. Frances Jenkins, inventor of broadcasting still photographs and motion pictures, points at his latest receiving camera. Impulses light the electric bulb. The light ray then passes through a shuttered moving prism and three revolving glass disks, and after focusing, to a screen. The transmitting camera is at the right. © Miller Service

## Community Antenna to Be Ready for Use Soon

### Will Permit Several Sets to Use Same Wires

WASHINGTON.—The "coupling-tube" unit, by means of which several receiving sets may use a single antenna, will be made available to the public soon after June 1, according to Naval Radio experts. The device was invented and perfected by Dr. A. H. Taylor and L. C. Young of the naval Radio laboratory at Bellevue, Md., and has been demonstrated on board the U. S. Battleship Colorado.

By connecting a coupling-tube unit between each receiving set and the single antenna suspended from the masts, several incoming messages on different wave lengths were received simultaneously, while three messages on other wave lengths were transmitted from the vessel.

The military value of the coupling unit to the navy is very high, since it enables a vessel or station to carry on several times as much business or traffic as has heretofore been possible without interfer-

ence. The navy holds the rights for military use.

To the public its chief interest will be that it will permit the use of a single aerial on a large apartment house or hotel, wherein each tenant wants to operate his own set independently of others.

## SUGGESTS STATION AS FIRE ALARM SOUNDER

### Washington Chief Sees Advantages in Emergencies

WASHINGTON, D. C.—Fire Chief George Watson of this city has asked the Electrical Engineer of the District of Columbia to consider the advisability of installing a broadcasting station at fire alarm headquarters here to be used in sending out fire alarms in emergencies.

He has also asked for an opinion on the possibility of obtaining Radio apparatus to communicate with the fire boat when that vessel is fighting a waterfront blaze from midstream.

The chief has pointed out that practically every fire engine house is equipped with receiving apparatus already.

## New Phonofilm Records Noises Outside Scenes

### Exterior Sounds Included to Increase Realism

NEW YORK.—A new phonofilm, with twenty persons in the cast, is being made here by Dr. Lee DeForest, inventor of the talking pictures, in his studio at East 45th St. It is the first time that such a large number of persons have been used in one picture, and also the first time that exteriors, with exterior sounds, have been photographed.

The story has to do with life on the east side of New York. Among the novelties introduced is a little German band which plays with all the fervor (and discord) for which such bands are noted. Every sound is faithfully recorded. The roar of the elevated railway, as a train passes overhead, the cries of the street vendors and the shrill voices of the children with the always present noise of their roller skates, are all reproduced amazingly realistic.

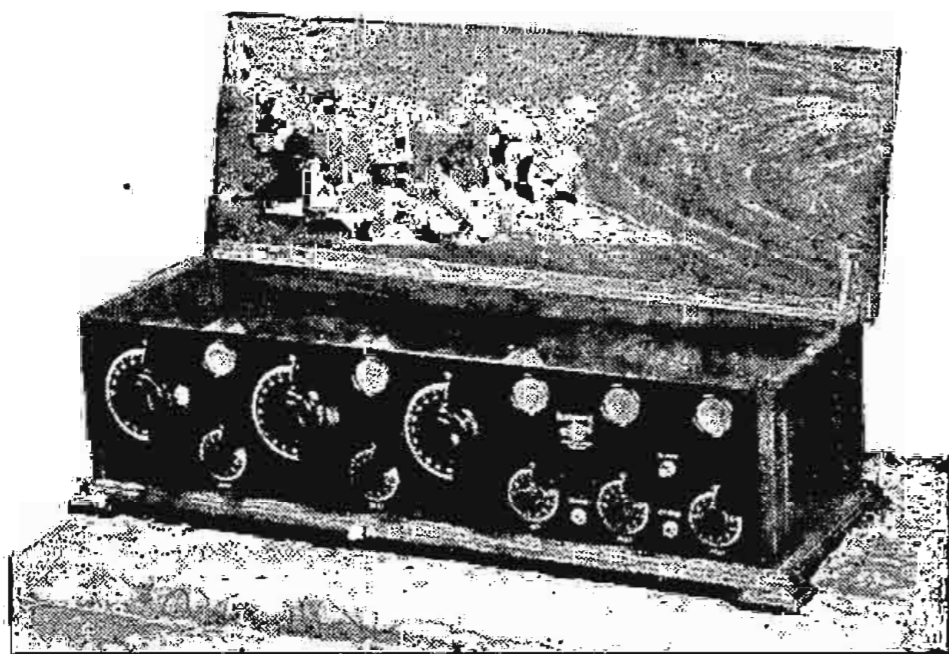

## The Howard 5-Tube Neutrodyne Coast to Coast Range

Beautiful black Walnut cabinet with special designed Howard Neutroformers, Neutrodones, special sockets and rheostats.

The Howard Neutrodyne brings the wonders of radio into your home and allows you to distinctly receive the famous broadcasting stations of the world.

Write Today for Descriptive Folder of This Remarkable Set

Howard Mfg. Co. is one of the few manufacturers licensed under Hazeltine patents to sell Neutrodyne receivers.

HOWARD MANUFACTURING COMPANY  
4346 NORTH WESTERN AVENUE  
CHICAGO

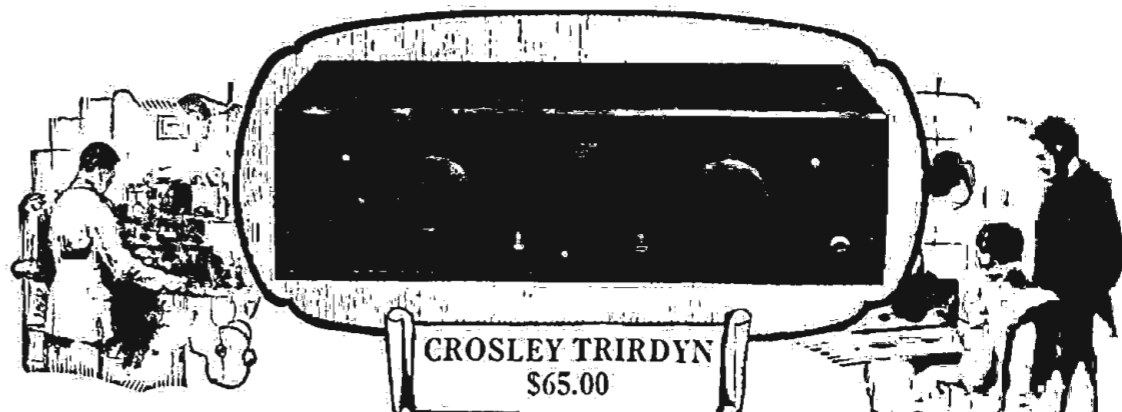
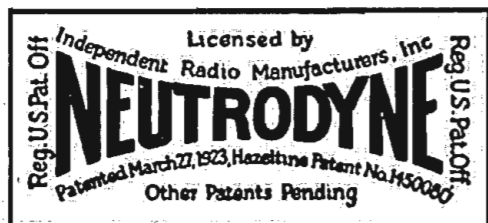

Approved by Over 200 Experts

## New Crosley Engineering Achievement

A three tube set with five tube efficiency—the greatest selectivity with the minimum effort—positive calibration to any wave length between 200 and 600 meters. These are only a few of the many advantages offered in the remarkable new Crosley Trirdyn Radio Receiver.

It was only after a year of constant experimenting, that our engineering department perfected this exceptional receiver. Thorough tests proved to us that it would out-perform any receiver ever before produced. We shipped out 200 of these sets to experts in every part of the United States. Their criticisms are one and the same—"tried out your new Trirdyn Receiver Saturday night and logged 13 stations, among them Cuba, New York and Omaha, between 9 and 10 o'clock. The set was very selective. During the time this test was on, local station KSD was operating and we went through them without any difficulty or interference whatever.

This new Crosley triumph is called the Trirdyn because of its original

combination of the three "R's"—Radio frequency amplification, Regeneration and Reflex. The first tube incorporates non-oscillating, non-radiating tuned radio frequency amplification; the second tube, a regenerative detector reflexed back on the first tube for one stage of audio frequency amplification. Then it has a third tube which acts as a straight audio frequency amplifier. It uses the ultra selective aperiodic antenna circuit and external selector coil, which adds to its wonderful selectivity.

The Crosley Trirdyn in range, volume and selectivity is the equal of any five tube receiver on the market. Any type of tube can be used with either indoor or outdoor antenna.

The opinions of many experts have convinced us that the Trirdyn is the best receiver ever offered the public regardless of price.

Practically every radio dealer can furnish you Crosley Radio Sets including all other models as well as the Trirdyn.

Licensed under  
Armstrong U. S. Patent  
No. 1,113,149

**CROSLY**  
Better-Cost Less  
Radio Products

See this new  
Crosley Trirdyn wonder  
at your dealer's

## THE CROSLY RADIO CORPORATION

Formerly the Precision Equipment Company and Crosley Manufacturing Company  
5491 ALFRED STREET  
Powel Crosley, Jr., President  
CINCINNATI, OHIO



# MORNING EXERCISES FROM STATION KYW

## EARLY BIRDS TUNE IN ON ALL THE BENEFIT

P. A. Leonhardt, Y. M. C. A. Physical Director, Teaches Listeners How to Swim on Dry Ether Waves

CHICAGO.—What is reputed to be the largest gymnasium class in the world's history, yet not crowded and perfectly private, is conducted every morning by the physical director of the Central Department of the Chicago Y. M. C. A., through Station KYW at 6:30 Central time, and again at 7:00 o'clock each morning except Sunday.



P. A. LEONHARDT

If you see any of your Radio friends limping down the street you will know that they have been trying out some muscles that they never knew they had before.

### Add or Lose Weight as You Wish

Several thousand are trying to get thin by Radio while others are using the Radio drills to gain weight. Enough testimonials come in from physicians, lawyers, housewives, farmers, school boys, and all other classes to make a patent medicine firm turn green with envy. One woman writes, "My mother, eighty-four years old, and her sister, seventy-six, are also limbering up with us."

# BEAUTY WHILE YOU LISTEN IN



Dr. Henry J. Shireson (right), world-renowned plastic surgeon of Chicago, makes use of Radio as a substitute for local anesthetics in his remarkable work of remodeling faces and beautifying the young and old, ladies and men. Miss Georgette Duprois, motion picture star, is here shown having a permanent bloom put on her cheeks. The surgeon also finds the airphone an asset in making permanent cupid's darts on the lips, removing double chins, "lifting" faces and removing wrinkles. Int. Photo

The exercises even follow a man to prison. R. L. King, assistant city editor on a newspaper, was sentenced to serve thirty days in jail for contempt of court.

### Now Teach Dry Land Swimming

As a short term prisoner, Mr. King was permitted to take his four-tube set as well as his typewriter to jail with him. He not only tunes in for his "daily dozen" in the morning, but with a loud speaker he is able to invite the other prisoners to take the setting-up exercises and later on in the day listen to music, speeches, news and other broadcast features.

The latest development in Radio exercises is the giving of lessons in swimming by George Scheuchenflug, commonly known as "XYZ," swimming instructor at the Chicago Central "Y." The week of April 28 to May 3 was to be known as "Learn to Swim" week and the dryland drill for the crawl stroke will be taught each morning via Radio. Listeners will be given an opportunity to show their dry land swimming proclivities in real water.

# World Radio Congregation Observes First Birthday

OMAHA, NEBR.—The first anniversary of the World Radio Congregation, an interdenominational religious service broadcast every Sunday at 9 a. m., Central time, from WOA-W, Woodmen of the World station here, was observed on a recent Sunday. The Rev. R. R. Brown, pastor of the Omaha Gospel Tabernacle who conducts the services regularly, preached the dedicatory sermon and received many replies by telegraph and telephone.

# Famous "Chauve-Souris" Goes on Ether at WDAR

PHILADELPHIA.—The broadcast treat of the week from Station WDAR, Lit Brothers here, was the famous Russian organization "Chauve-Souris", microphoned in entirety from the stage of the Shubert Theater.

# CLEVELAND STUDIOS WORK WITH PAPERS

## STATIONS AND DAILIES IN CLOSE HARMONY

Recent Tie-ups of WHK and WTAM, Like WJAX, Gives City More Excellent Programs

CLEVELAND.—Definite relations have been established between the broadcasting stations and morning and evening dailies of this city. WJAX, the broadcasting station of the Union Trust company, and the Cleveland News-Leader have been in close contact almost from the first broadcasting from this station. The News-Leader provides Tuesday evening programs that have been a pleasing feature of the weekly schedule.

WHK, station of the Radiovox company, has recently arranged with the Cleveland Press for this newspaper to provide Friday evening programs and a daily summary of news items that are broadcast at 5:30 p. m., with the baseball scores. The Press will maintain the same high standard of orchestral offerings that have always characterized the Friday evening programs.

### WTAM Makes Tie-Up

On Wednesday, May 7, Station WTAM, the Willard Storage Battery company, will broadcast the first of the WTAM-Cleveland Plain Dealer programs from the new studio in the Plain Dealer building, operated by remote control from the WTAM station, about eight miles distant. The Plain Dealer has provided a program of notable excellence for the opening evening's entertainment, and will maintain the very pleasing variety of high class entertainment that has been always offered by the Willard Storage Battery company on its Wednesday night programs.

The Sunday evening programs of WHK will be continued as at present and as arranged by the Radiovox company. The now famous Saturday evening dance programs from WTAM will also be continued as usual.

In Canada there are now thirty-six stations broadcasting, many of which are heard in the United States. They are all identified by their initial call letter C, except special Government broadcasters.



# "Me, too!"

This is our WARNING in fairness to you and to us. Create a success, and instantly the "me, too" boys will seek to capitalize your reputation.

Speaking with authority as the largest radio dealers in America, we know of no others large enough to both meet our price and also give our quality of goods.

Aside from this is the question of Design—vital to superiority. Anyone can pick up an assorted kit of parts and offer it for sale—but no one meets our selection, which comprises a Matched Set following our proven, incomparable mechanical and technical Design which we alone distribute.

The De Luxe Neutrodyne—genuine, standard, matched and licensed Hazeltine Neutrodyne parts—brings to everyone, rich or poor, the ultimate greatest achievements of Radio.

# 5 TUBE NEUTRODYNE \$34.49 Knock-Down Set COMPLETE

Written Money-Back Guarantee Sent With Each Purchase

## SEND NO MONEY We Ship C. O. D.

### Complete Kit of STANDARD PARTS

- 1 Drilled Radion Mahoganite Panel, engraved in gold.
  - 3 Four-inch Radion Mahoganite Dials, gold engraved.
  - 2 Gold Plated Jacks.
  - 2 Genuine Hazeltine Neutroformers mounted on the famous Comsco Bakelite End Condensers. Positively the only Neutrodyne Kit including these famous Comsco Condensers.
  - 2 Hazeltine Neutrodons.
  - 5 Bakelite Sockets.
  - 1 6-Ohm Rheostat with gold plated knob to match panel.
  - 1 30-Ohm Rheostat with gold plated knob to match panel.
  - 2 Genuine Killark Shielded Audio Transformers.
  - 1 Baseboard.
  - 20 feet Tinned Bus-bar.
  - 1 .00025 Freshman Grid Condenser.
  - 1 Tubular Glass Grid Leak.
  - 1 Set Engraved Binding Posts.
  - 1 .002 Micon Condenser.
  - 1 .006 Micon Condenser.
  - Exact size special panel and base blueprint.
  - All packed in attractive box. Written Money-Back Guarantee.
- Complete Assembly Kit, Genuine 5-Tube Hazeltine Neutrodyne **\$34.49**

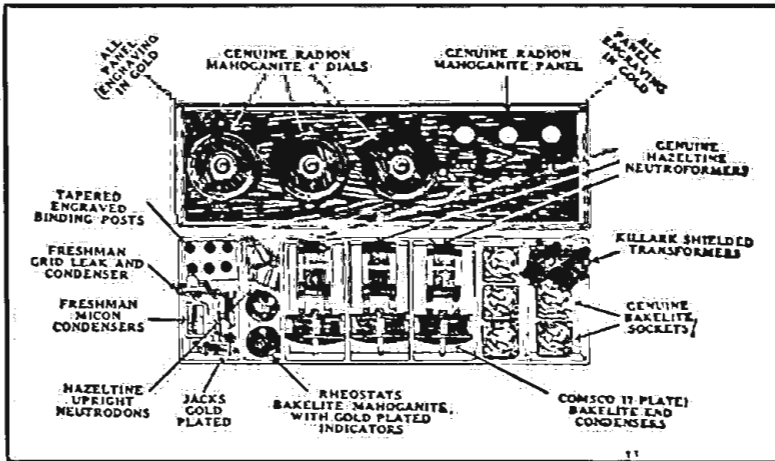

ALL Parts LICENSED ALL Parts MATCHED Fine Workmanship GENUINE HAZELTINE NEUTRODYNE

# CABINET FREE

Here is EVERYTHING needed to operate this coast-to-coast set after building: 5 Tested Tubes (Type 201A) \$19.50 2 45-Volt Extra Large Variable "B" Batteries for Neutrodyne 6.50 1 60 Ampere Hour Storage Battery, guaranteed 2 Years 11.25 1 pr. 3000-ohm Head Phones and Cord 3.75 1 Antenna Equipment 1.50

## Complete Outfit, \$43.40 (Parts Also Sold Separately)

If you order Building Kit and Operating Outfit both together, we will include Fine Mahogany Finish CABINET FREE.

# The RADIO-SHACK

EXECUTIVE OFFICE: 55 Vesey Street, Dept. RD-53 NEW YORK CITY

Send no money. We ship C. O. D. Pay your postman. Then build your set under our WRITTEN Money-Back Guarantee sent with shipment. We acknowledge all orders by return mail. Ship same on following day. We answer every letter we get—on same day. The Radio Shack are the Largest Radio Dealers in America. No inferior goods. Only the best and most reliable. You buy in safety. Send your C. O. D. order today. This present low price may not continue. Use the coupon NOW.

The Radio Shack, Dept. RD53, 55 Vesey St., New York, N. Y.

Mark X here only to order Radio Set

Mark X here only to order Accessories

If I have marked a cross (X) in UPPER square at left, send me the De Luxe Neutrodyne \$54.99 C. O. D. If I have marked a cross (X) in LOWER square at left, ship me Comsco etc. (to fit) Operating Accessories, \$45.40. C. O. D. Send CABINET FREE. I have ordered both together. Everything ordered is subject to your WRITTEN Money-Back Guarantee.

NAME (Print Plain) ADDRESS



# OPERATING AND TROUBLE SHOOTING

For the Owner of a  
**HOWARD**  
Neutrodyne Receiver

**"OPERATING and Trouble Shooting"** is a Radio Digest feature whose purpose is to study the late models of various standard receiving sets and to show the newly initiated broadcast listener, who has purchased such a set, how he can operate it to get the best there is in it and how he can overcome minor difficulties which may be causing some trouble. On pages 11 and 12 this week, the Howard Neutrodyne Receiver is described. Radiophans with other sets will also find these articles worth reading, particularly the notes on trouble finding.

**T**HE Howard receiver is a neutrodyne of the latest and most approved design and construction. Its operation is simple and its performance as to quality for the local stations and extreme sensitivity for distant stations is such as to put it in the front rank of modern Radio receivers.

To obtain the best results with the Howard it is necessary that it be carefully installed according to the following instructions.

### Antenna and Ground

The first items to be considered in setting up a Radio receiver are the antenna and ground. If it is desired to hear only the local stations and the more powerful stations within a radius of 500 miles, a

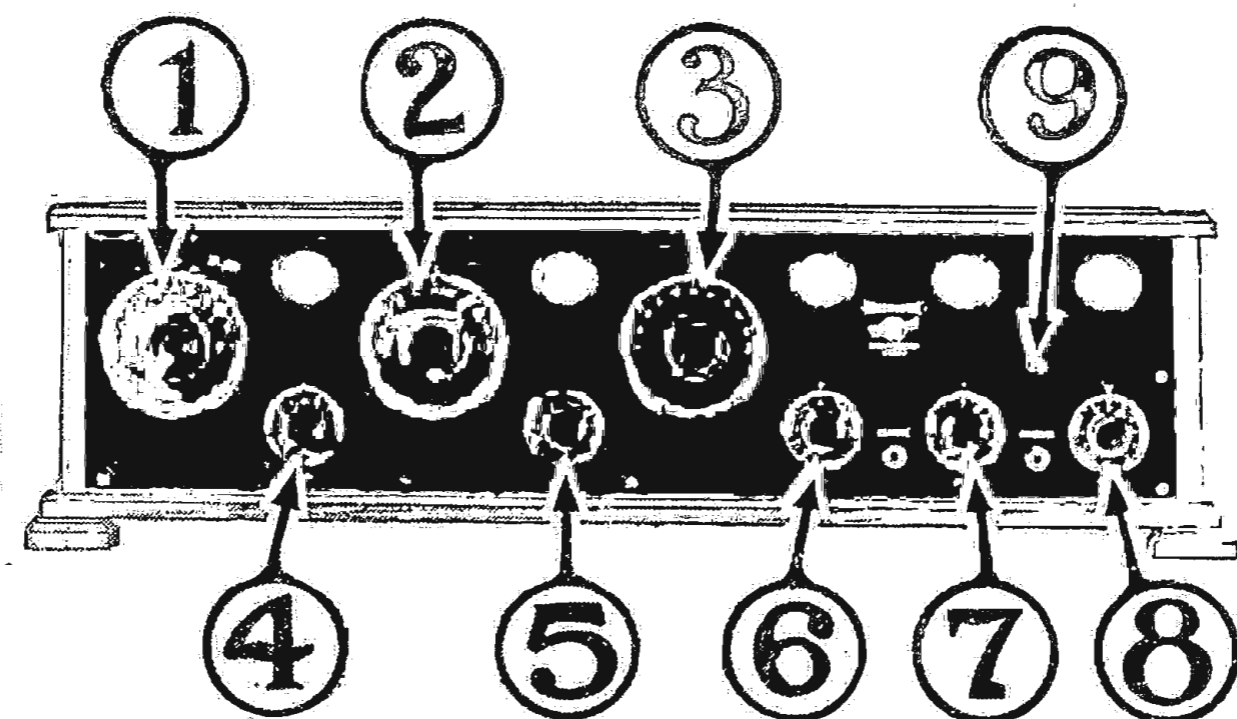

small indoor antenna is not only sufficient but is most desirable, since less interference due to static and spark stations will be picked up on this than on any outdoor type. This antenna may consist of twenty or thirty feet of insulated wire strung clear of the walls in a hallway or attic.

Use of the electric lighting system as an antenna by means of a well insulated plug frequently gives good results even on distant stations. This scheme at times provides the best type of antenna, especially in steel framed buildings, as they shield the Radio waves from other types of indoor antennas.

If it is desired to receive stations a long distance away, an outdoor antenna about sixty feet in length will usually give the best results. It should, of course, be well insulated and protected against lightning with a grounding switch or lightning arrester as specified by the fire underwriters. Even if one has an outdoor aerial at his disposal he should also provide an indoor aerial for use in receiving local stations.

The ground connection in all cases should be as short and direct as possible. Connection to the radiator system or water piping system is generally satisfactory.

### Accessories Needed

A 6-volt storage battery of 50 or more ampere-hour capacity and B batteries totaling 90 volts should be provided.

The Howard receiver is designed for five UV-201A or C-301A tubes.

A good loud speaker or phonograph attachment should be provided. This should include a cord and plug. If desired, a pair of telephone receivers with head-strap, cord and plug may be used. They are sometimes helpful in tuning in distant stations.

### Installation of Receiver

The receiver should be so placed that when viewed from the front the antenna lead-in is at the left of the receiver. Connect this lead-in to the binding post marked A, being careful to run it in such a way as not to come close to the right-hand side of set. The safest procedure is to run it straight back from the receiver and thence to the antenna. The lead from the ground should be connected to the terminal marked "G."

The batteries should be placed as shown behind the set, or, better still, on a shelf or on the floor, beneath the set. It is a wise precaution to connect the A battery first and to insert all five tubes with

the rheostat with the five small dials at the bottom of the panel turned to about fifty divisions. The tubes should then all light up. If they do not, error has been made which should be corrected before connecting to the set.

After the connection is made, turn up the rheostat dial 4, 5, 7, 8 and 8 to about fifty divisions so that the tubes are lighted and insert the loud speaker plug in the jack at the extreme right of the panel. (If headphones are used they should be plugged in the other or hand jack.)

Tap the detector tube (the first one) lightly with the finger and a note should be heard in horn. The best combination of the elements of the tubes should then be interchanged until the one giving the least drawn-out note is obtained. This note should be left in the middle socket while the other four may be placed at random in the other four sockets.

### Tuning In

The receiver is now ready for use. Turn all three of the larger tuning dials 1, 2, and 3 to the same points of their scale (90 divisions, for instance), and then make small readjustments to dials 1 and 2 until a slight crackling or roaring noise which is due to the carrier wave of the station sending. A loud, unsteady noise is due to static and other atmospheric disturbances and is more noticeable when using an outdoor antenna. The receiver is now tuned to a wave-length of approximately 536 meters, which corresponds to a frequency of 560 kilocycles per second. If a broadcasting station within range is transmitting on this wave length it will, of course, also be heard. If no music or speech is heard, turn all three dials downward a division or two at a time until a station is picked up. As the dials are moved downward the receiver is tuned to lower and lower wave lengths.

After a station has once been heard the settings of the three tuning dials should be recorded on the log sheet provided. To receive signals from it at any future time, it is only necessary to reset the dials to the points recorded on the log.

The signals from powerful local stations are likely to be too loud and perhaps distorted. This may be remedied by either using a small antenna or by turning the

(Continued on page 12)

## BUELL

*E. J. Flewelling*

### RADIO APPARATUS

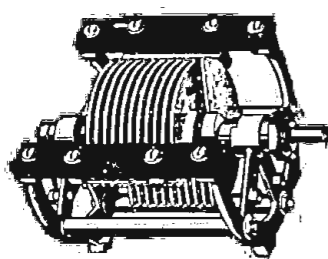

The Buell Condenser is the utmost in skillful construction and scientific design. Built to last, to stand more than ordinary abuse, it is extra rugged; it is as near electrical and mechanical perfection as human ingenuity can make it. Supplied in .0005 mfd. capacity. Price . . . **\$7.00**

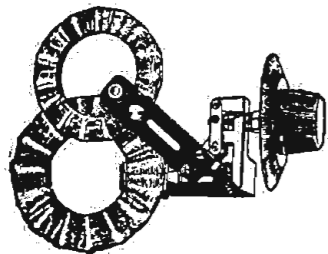

The Buell Tuner is more than an ordinary piece of tuning apparatus; it is designed and constructed with the same painstaking care as all other Buell Parts. It is built to produce satisfactory results and render the acme of service. Price **\$8.00**

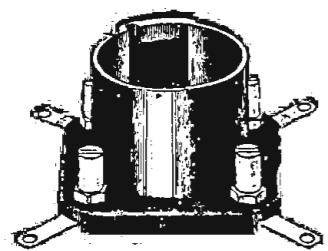

Short direct terminals; contacts of the improved "side-wiping" design are the secret of the Buell Socket. This socket is surprising in its performance. The positive contacts assure permanent connections and elimination of so called "tube noises" that many times are the result of a faulty socket. Price . . . . . **\$1.00**

**BUELL MANUFACTURING COMPANY**  
2977 Cottage Grove Ave.  
CHICAGO

**CONDENSERS TUNERS SOCKETS**

## COMSCO CONDENSERS

"All you really need know about a condenser is that it's a COMSCO"



COMSCO

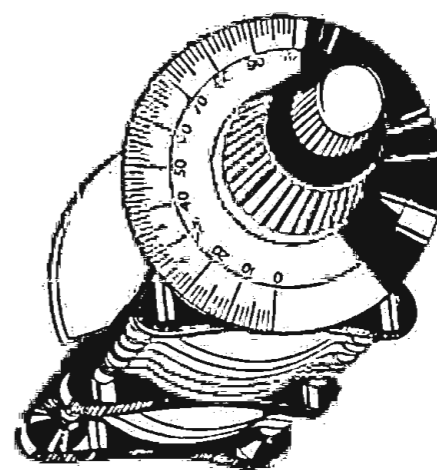

COMSCO

The most ingenious variable air condenser ever conceived  
No outside Spring Connections—True Capacities.

and Remember the Bronze Bushings!

Bronze Bushings for Permanent Contact—A ComSCO Feature

11 plate plain . . . . . \$2.00	16 plate vernier . . . . . \$4.00
17 plate plain . . . . . 2.25	26 plate vernier . . . . . 4.50
23 plate plain . . . . . 2.75	46 plate vernier . . . . . 5.50
43 plate plain . . . . . 3.50	All Tested Instruments

MADE BY THE MAKERS OF  
THE ORIGINAL AUTOMATIC  
BULL DOG GRIP TELEPHONE PLUG

For One Pair Phones  
**\$1.00**



For Two Pair Phones  
**\$1.50**

ASK FOR COMSCO AT YOUR DEALER

Otherwise send purchase price direct to us and you will be supplied

## GENERAL INSTRUMENT CORP.

423 Broome Street  
NEW YORK CITY





### OPERATION, TROUBLES

(Continued from page 11)

the dials of the first two rheostats until good, clear and sufficiently loud signals are heard.

#### Interference

Interference experienced by Radio listeners is chiefly of three kinds. These are:

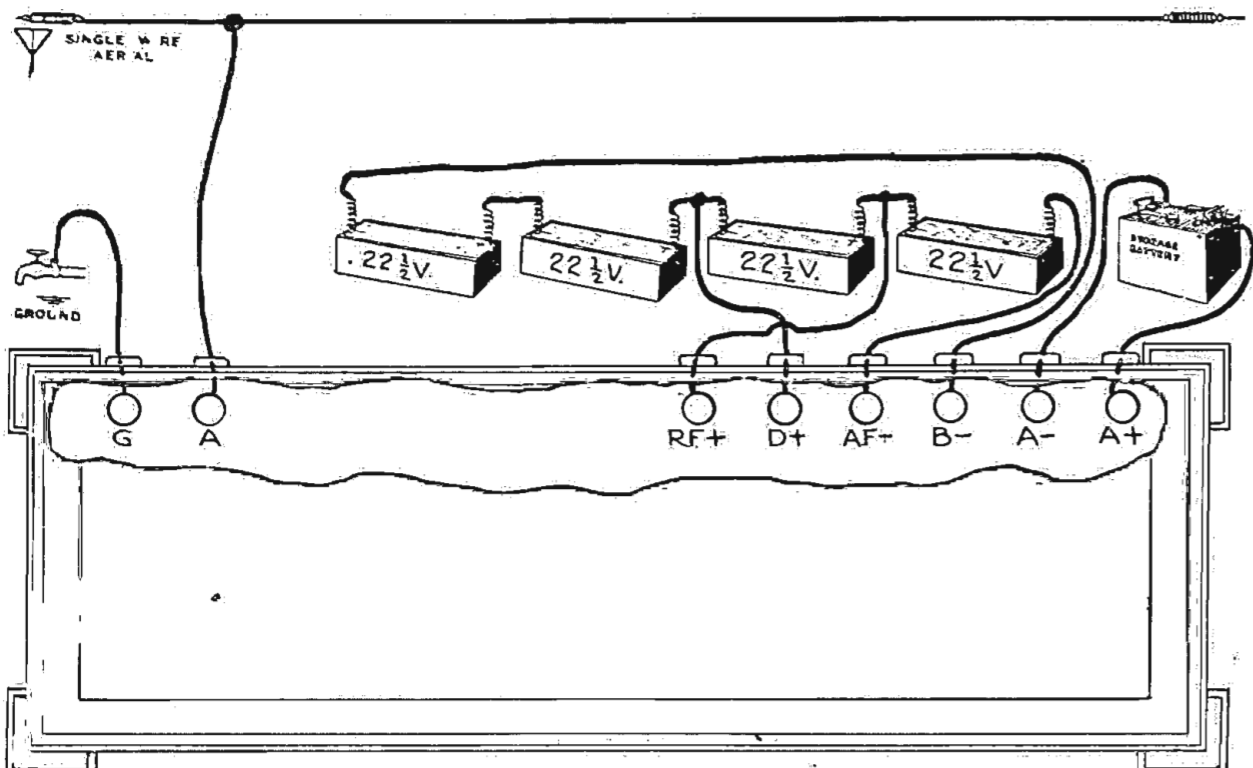

Interference between broadcasting stations; interference from static, atmospheric disturbances and spark stations; and interference from reradiating oscillating receivers.

The Howard receiver is sufficiently selective to largely exclude interference between broadcasting stations, especially when a small or indoor antenna is used. If, however, the broadcasting stations transmit on incorrect wave-lengths interference in the nature of a steady squeal or howl of almost unvarying pitch results,

which, of course, is impossible to eliminate.

The second type of interference—that due to static, etc., can be minimized, if objectionable, only by the use of a small outside antenna or an indoor antenna.

The third type—that due to re-radiation from oscillating receivers—is characterized by squeals and chirps which vary

in pitch. Very little can be done to eliminate them until the re-radiating type of receiver is eliminated. The Howard neurodyne does not oscillate nor re-radiate, and therefore does not produce this very objectionable interference, which is causing annoyance to the listeners-in.  
(ANOTHER SET NEXT WEEK.)

Eighty colleges and universities in the United States have broadcasting stations.

## COAST-TO-COAST RECEPTION —and Beyond—

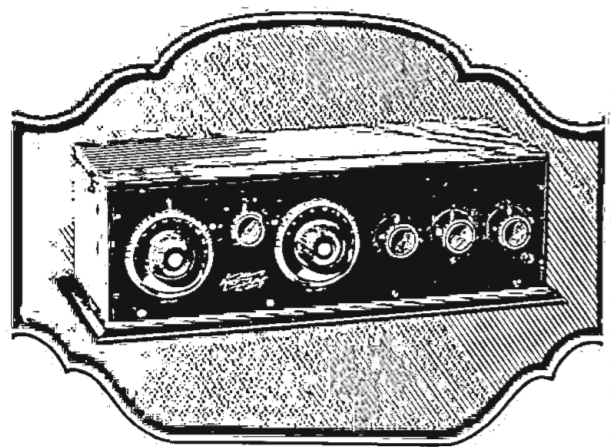

# Radiodyne

"The Voice of the Nation"

NO LOOPS . . . NO AERIAL

WITH the RADIODYNE you can select broadcast programs from all parts of the country. Honolulu and London have often been picked up by operators in the central states without interference from nearby stations.

The Radiodyne is ready for operation by simply grounding to a water pipe or radiator, and throwing a few feet of wire on the floor. Uses any standard tubes—dry cell or storage battery. Extremely selective. Simple to operate—Only two controls—you can tune in on any program you wish—any wave length from 200 to 700 meters.

For use in apartments, boats, automobiles, railroad trains, etc., the RADIODYNE is enjoyable where other receiving sets would not be practical.

Price, \$150.00

Write for illustrated folder which describes the RADIODYNE in detail. Every radio fan will be interested in this new type (antennaless) receiving set.

Western Coil & Electrical Co.  
312 5th St. Racine, Wisconsin

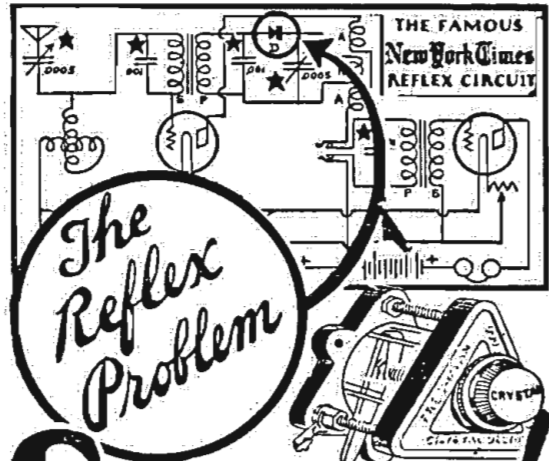

## SOLVED!

### FRESHMAN DOUBLE ADJUSTABLE CRYSTAL DETECTOR

The World's Best for crystal or reflex sets  
This crystal detector

makes two tubes do the work of four!

**FREE!** Send for Freshman Building Plan of N. Y. Times Reflex—gives panel layout, circuit and parts required. Operates Loud Speaker on two tubes!

FRESHMAN Double Adjustable Crystal Detector for panel or base use, complete with crystal. **\$150**

Freshman Super - Crystal With Non-Metallic Housing **50c**

No more searching for the sensitive spot, merely turn the knob as you would a dial! At your dealer's; or send purchase price to be supplied postpaid.

Chas. Freshman Co. Inc.  
Radio Condenser Products  
106 Seventh Ave., N. Y. C.

# 5 Tube Neurodyne

PAY NO MONEY

Just Pay The Postman

## \$12.50 CABINET FREE

Special Ten Day Offer with Each Set

On account of this special offer you must pay the express

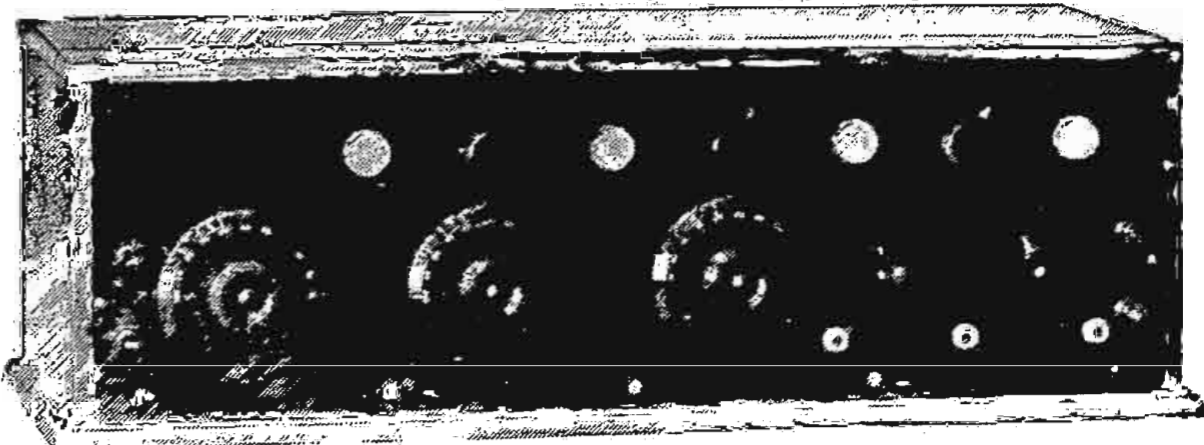

8x26x8, Mahogany, Walnut, Oak, with Piano Hinges

## ALL STANDARD PARTS

WHEN you get this magnificent looking set wired and hooked up, you will be able to hear all stations without interference. All parts are same as illustrated in Radio Digest, Feb. 2nd. Panel is mahogany with beautiful mahogany dials—a set fitted for the most exclusive home.

2 Rheostats, 25 ohms, Howard.....	\$ 2.00
1 Rheostat, 6 ohms, Howard.....	.90
3 Air Core R. F. Transformers, mounted on condensers, and 2 balancing condensers.....	20.00
1 Potentiometer, 1850 ohms, Federal.....	1.85
3 Jacks, Carter.....	2.70
2 .006 Condensers.....	.40
1 Grid Leak with Condenser, Walnut.....	.65
5 Sockets, Kellogg's.....	5.00
2 Transformers, All-American.....	9.50
9 Readem Binding Posts.....	.85
1 8x26 Mahogany Panel.....	3.64
4 Bezels.....	.80
3 Dials, Mahogany, 4 in.....	4.50
1 Baseboard.....	.50
24 ft. Square Bus Wire.....	.60
24 ft. Spaghetti.....	.80
	\$54.69
For Ten Days, Cabinet.....	12.50
	\$67.19

BLUE PRINT FREE  
EASY TO WIRE

# \$48.50

SEE BELOW

Mounted on Panel and Baseboard

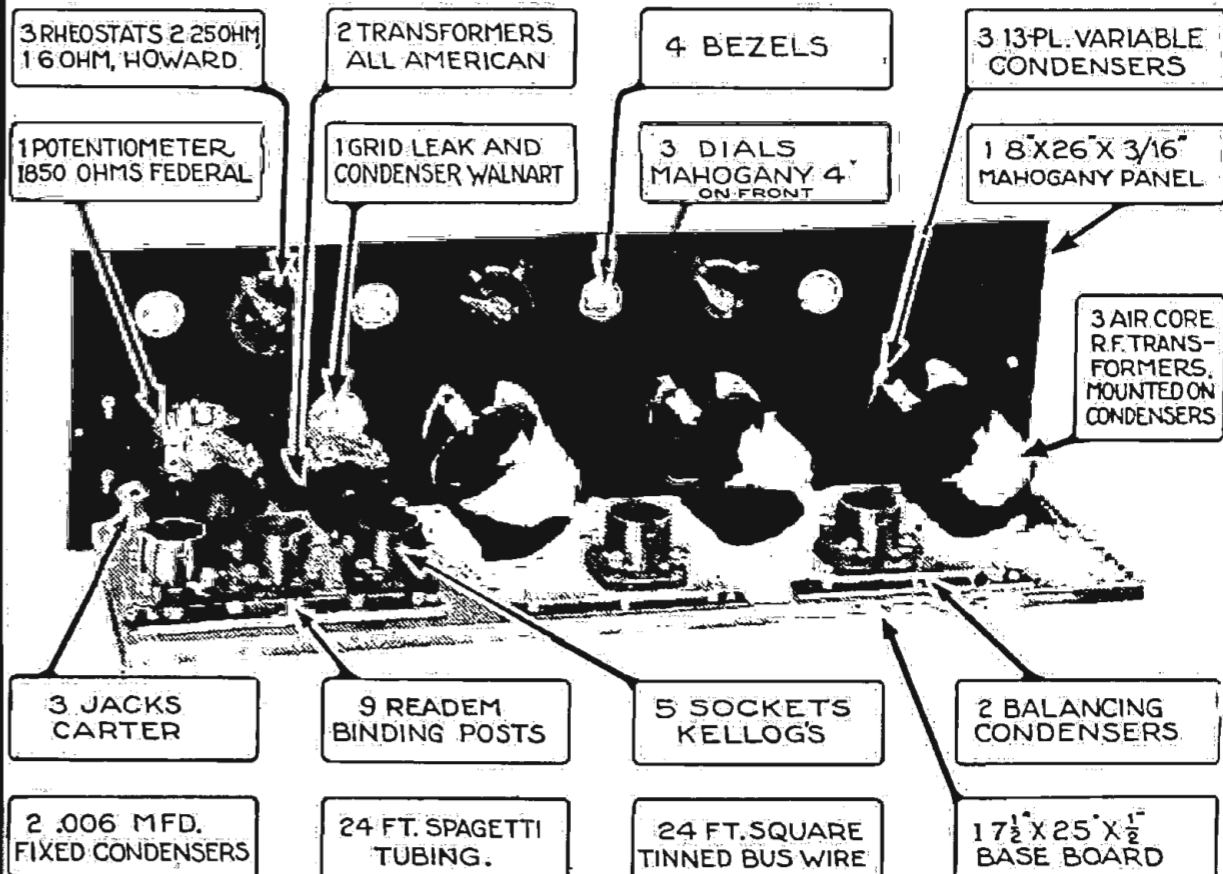

Panel not mounted or drilled, only \$45.50 with \$12.50 Cabinet and blueprints FREE.

## COMPLETE WITH ALL EQUIPMENT

IN ADDITION TO ABOVE PARTS

5 Tubes.....	\$25.00	2 22 1/2 Volt B Batteries.....	\$ 6.00
1 10 Ampere Storage Battery.....	18.00		
1 DeLuxe Homecharger.....	18.00		\$86.00
1 Headset.....	12.00	Loud Speaker.....	12.50
1 Complete Aerial Equipment.....	1.50		
1 45 Volt B Battery.....	5.50		
		TOTAL.....	\$98.50

The above parts and equipment complete would cost you \$159.50! Our Price \$125.00

Written Money Back Guarantee with Each Set

Special Sale on Webster Condensers, Fine for Super-Heterodyne

Variable Condenser, .0005 (same as 23 plate), \$2.98 list, \$5.50. While they last—Bargain at..... Variable Condenser, .001 (same as 45 plate), \$2.98 list, \$6.00. Big buy at.....

We are responsible folks, money cheerfully refunded within ten days if you are not satisfied

All Orders Mailed Promptly. No Stamps Accepted. Send Check or Money Order.

Quality Merchandise at Low Prices  
**Economical Radio House**  
4600 LINCOLN AVENUE, CHICAGO

Everything in Radio. Write Us

We Personally Guarantee All Goods



# What's Wrong with Your Receiving Set?

## Chapter X—Adjusting or Balancing-Out the Neutrodyne Circuit

By Peter J. M. Clute

THE secret of the great popularity of the neutrodyne circuit lies in the fact that it is possible to construct a receiver which combines a relatively high degree of efficiency and simplicity of operation.

The neutrodyne employs the basic principle of tuned Radio frequency amplification, together with complete neutralization of the inherent capacity coupling of the vacuum tubes and their associated circuits. While the internal capacity

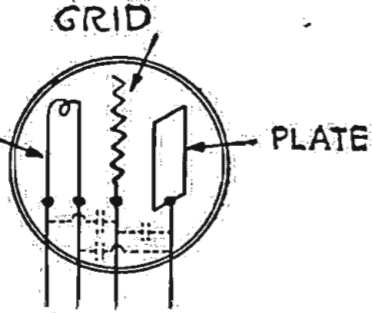

Figure 1.

existing between the grid and plate in the vacuum tube is exceedingly small, under certain operating conditions, the resulting oscillation and regeneration in the amplifier tubes is somewhat of an impediment to good reception.

It is generally known that a small tube capacity may have quite a harmful effect at high frequencies, more particularly in the case of Radio frequency amplification. Figure 1 illustrates graphically the condition existing between the elements of the vacuum tube. The dotted portions represent the capacities between the elements. The small capacities existing between the filament and grid and between the grid and plate are responsible for the production of an oscillating current in the plate circuit, especially if the latter contains any amount of inductance.

### Tube Capacity Neutralized

In the neutrodyne circuit this inherent tube capacity is neutralized by means of another capacity of equal value so inserted in the circuit as to balance the capacity effect within the tube. The critical adjustment of the neutrodyne depends upon the neutrodon or neutralizing condenser which consequently should have practically no losses at Radio frequencies and should have an extremely low capacity, capable of fine variation between one and ten micro-microfarads. The usual connection for the neutrodon is between the grid of one tube and the secondary winding of the neutroformer between that tube and the succeeding one. The connection to the tap on the secondary wind-

ing in conjunction with the critical adjustment of the neutralizing condenser produces the required balance. Proper neutralization obviously depends not only upon the correct position of this tap connection but also upon the selection of properly designed neutrodons to produce the desired results.

It is, perhaps, advisable for the operator to become familiar with the various tuning operations and the approximate dial settings of the particular set, before attempting the neutralization of the receiver. It should be borne in mind that the correct operation of the neutrodyne requires that all three of the neutroformer circuits be tuned to the same wavelength. After tuning in a station of known wavelength, the operator should log the station, its wavelength, and the neutroformer dial readings. While these settings will change somewhat after the balancing-out operations are performed, still they will constitute an operating guide for tuning in other stations.

It must not be imagined that the balancing or neutralizing operation is easy. Too many otherwise good receivers are left unfinished, either because the neutralizing process is not properly carried out or the operator does not possess the necessary detail information connected with the balancing-out method.

### Balancing-Out Process

In practice, the balancing-out process consists in exciting the coupled circuits of the receiver with a strong signal and then neutralizing the tube and coupling capacities, in effect preventing the signal from being heard. Inasmuch as this ad-

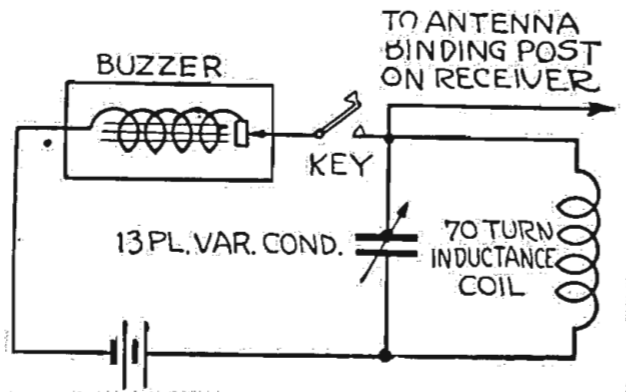

Figure 2.

justment is made for minimum or inaudible strength of signal, it can consequently be accomplished very exactly. Since this procedure is carried out with the filament circuits of the vacuum tubes rendered temporarily inoperative, it is readily apparent that it is a method of capacity neutralization and not one of

eliminating or reducing oscillation or regeneration.

### Exciting Circuits for Balancing

There are two ways of exciting the coupled receiver circuits for the balancing-out procedure. In the first method, a nearby or local broadcasting station of medium signal strength is tuned in. The reception should be clearly heard but not so loud as to be uncomfortable for the listener. When a strong signal is tuned in for this purpose, it is highly probable that the neutroformer secondaries will ab-

by a buzzer, as indicated in Figure 2. It is advisable to locate this apparatus some distance from the receiving set, leading one wire to the antenna binding post on the receiver. The circuit arrangement is completed by making a ground connection to the ground terminal, and by connecting the A and B batteries to their respective binding posts. The vacuum tubes best adapted for this type of receiver are UV-201A or C-301A for the Radio and audio frequency amplifier and UV-200 or C-300 for the detector.

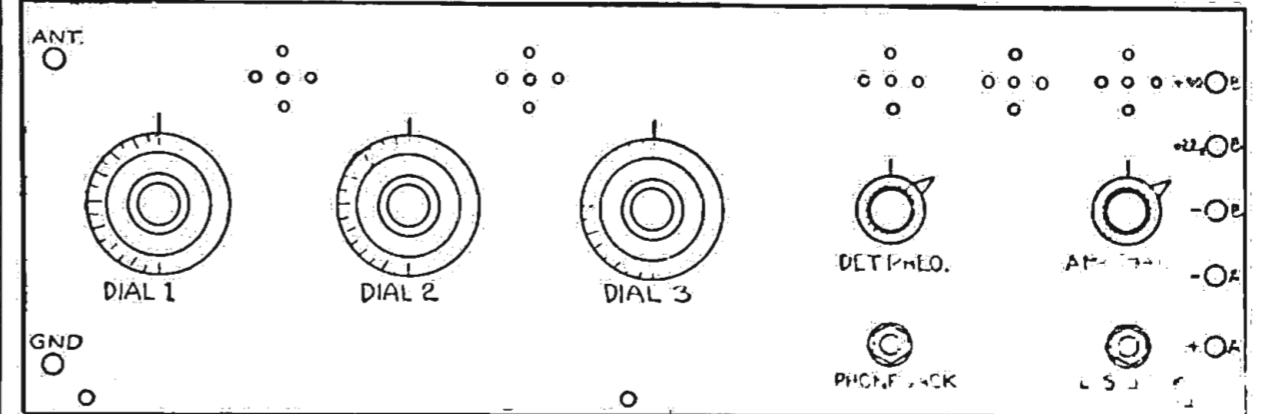

Figure 3.

sorb sufficient energy to give loud reception. In such a case, there will be no perceptible difference when balancing is tried out, inasmuch as Radio frequency amplification is only effective to a small degree at short distances. On the other hand, tuning in a very weak signal makes matters worse, because it can be detuned so easily that it will be almost an impossibility to balance the receiver properly. Consequently, it is advisable to select a station between the two limits noted above, being careful to avoid a local station where the signal strength is very great.

The second method of exciting the receiver for the neutralization process makes use of an external oscillating circuit, consisting of a 70-turn inductance coil and a 13-plate variable condenser, excited

### Tuning In Signal

If the first method given above is employed, a signal of medium strength is tuned in for the balancing-out procedure. If the oscillator circuit is used, the buzzer signals will supply the necessary excitation. With the filaments of the vacuum tubes lit, the amplifier tubes rheostat should be turned as far as possible to the left and the vernier detector rheostat adjusted to a point just before sputtering sounds are heard in the phones. Next all three of the neutroformer dials should be turned about in step with each other in order to pick up the buzzer signals, after the variable condenser in the oscillator circuit is placed at approximately a wavelength setting of 250 meters.

(Continued on page 22)

# Thrills from Radio

No. 18 of a Series Featuring Experiences of "ALL-AMERICAN" Users

## A New Distance Record

By Earl G. De Haven, Los Angeles

"On December 8th, I heard a concert from OA, the 150-watt station at Ottawa, Canada. In reply to my card, they informed me I had set a new distance record for their station, 2400 miles.

"This makes another record for All-American Transformers and is additional proof of their superiority in long distance radio reception.

"My set is home-made and consists of detector and two stages of amplification. Am using two

All-American Audio Frequency Transformers, 10:1 and 5:1. I do most all distance work with two tubes, detector and one-step.



All-American Audio Frequency Transformers. 3:1, \$4.50; 5:1, 10:1, \$4.75. The best—no necessity to pay more.

"With my All-American 10:1 I have heard more than 60 distant stations — from Calgary, Canada, to Havana, and Ottawa to Mexico City.

"The only transformer that is equal to an All-American is another All-American."

Special Offer All-American Power Amplification diagram-circular and Book of 22 Tested Hookups sent for 4c in stamps to cover mailing.

All the better dealers sell the "ALL-AMERICAN"

RAULAND MFG. CO., 2640 Coyne St., CHICAGO PIONEERS IN THE INDUSTRY

Audio and Radio Frequency Power Amplifying (input and output)

More than 700,000 in use Standard on the better sets



# ALL-AMERICAN AMPLIFYING TRANSFORMERS

Largest Selling Transformers in the World

RADIO BY MAIL		SIMPLEX RADIO SALES CO.		CASH OR C. O. D.	
1806 LaFayette Ave., Dept. C		ST. LOUIS, MO.			
COCKADAY KIT. Complete parts for improved 5-tube set exactly as specified by Mr. Cockaday. Less Cabinet.....	\$49.75	ULTRADYNE KIT. 4 Ultradyne special transformers, 1 Tuning Coil, 1 Oscillator Coil and Book of Instructions.....	\$20.58	SUPER HETERODYNE KIT. 3 No. 1716 Transformers, 1 Oscillo Coupler, 1 Filter Coupler and Instructions.....	\$43.95
<b>COCKADAY PARTS</b>		<b>ULTRADYNE PARTS</b>		<b>SUPER-HETERODYNE</b>	
Silk-wound Bakelite Coils.....	\$ 3.19	Ultradyne Tuning Coil.....	\$ 2.09	\$36.50 BRANSTON KIT.....	30.66
Amplex Grid-densers.....	.89	Ultradyne Transformers.....	4.19	Acme 30-KC Tran. formers.....	4.49
Lavite Resistance (48,000 ohm).....	.96	Ultradyne Oscillator Coil.....	1.68	7"x40"x9" Special Cabinet.....	9.97
Amsco 6-ohm Rheostat.....	.84	6-Tube Kit of Parts, comp.....	40.08	<b>FDRMICA PANELS</b>	
Amsco 20-ohm Rheostat.....	1.04	8-Tube Kit of Parts, comp.....	51.26	1/2" cut any size, sq. in.....	\$0.01 1/2
Amsco 400-ohm Potentiometer.....	1.47	7"x24"x7" Cabinet.....	5.59	3/4" cut any size, sq. in.....	.02
Amsco 26-pl. Vern. Condenser.....	3.78	7"x30"x7" Cabinet.....	7.49	1" cut any size, sq. in.....	.02 1/2
Amertran Transformer.....	5.59	<b>VACUUM TUBES (R. C. A.)</b> WD-11, WD-12, UV-199, UV-200, or UV-201A RADIDTRONS (Guaranteed Firsts).....		\$4.24	
Como Transformers (pr.).....	9.36	<b>FREE OFFER</b>		11 pt. \$0.94 Vernier \$ 1.89	
7"x24"x9" Special Cabinet.....	7.42	With each order for \$15.00 or more we will give a \$1.00 approved porcelain lightning arrester FREE OF CHARGE. This coupon must accompany your order.		23 pt. \$1.19 Vernier 2.19	
<b>ERLA REFLEX PARTS</b>				43 pt. \$1.34 Vernier 2.49	
Erla Reflex Transformers.....	\$ 3.89			<b>BREMER-TULLY CONDENSERS</b>	
Erla Audio Transformers.....	3.89			11 pt. \$2.01 Vernier \$ 3.89	
Erla Selectoformer.....	3.98			23 pt. \$2.52 Vernier 4.19	
Erla Crystal Detector.....	.79			43 pt. \$2.94 Vernier 5.04	
Hilco Variocoupler.....	5.78			<b>AUDID TRANSFORMERS</b>	
11-pt. Rathbun Condenser.....	2.56			Heeghog, 3-1, 4-1, and 5-1.....	
23-pt. Rathbun Condenser.....	2.86			\$ 2.79	
<b>BATTERY CHARGERS</b>				All American, 10-1.....	
2 Amp. Tungar Type.....	\$ 9.19			3.64	
5 Amp. Tungar Type.....	17.65			All American Push-Pull.....	
Gold Seal Homecharger.....	13.24			9.97	
Valley A. B. C. (new style).....	14.95			Thorlanson Push-Pull.....	
\$18.00 2 Amp. G. E. Tungar.....	15.89			9.97	
\$28.00 5 Amp. G. E. Tungar.....	22.95			Acme Audio or Radio Trans. 3.64	
<b>CROSLLEY SETS</b>				<b>MISCELLANEDUS</b>	
Model V 1-Tube Regenerative.....	\$13.44			Brandes Superior Phones.....	
Model 51 2-Tube Regenerative.....	15.34			\$ 4.59	
Model 3B 3-Tube Regenerative.....	35.26			Brandes Table-Talker.....	
Model XJ 4-Tube Tuned R-F.....	44.75			7.98	
Model XJ-Super 4-Tube.....	54.56			B-T Vernier Tuner.....	
<b>B BATTERIES</b>				Tonic Sam Tuning Coil.....	
(Burgess or Eveready)				4.76	
22 1/2-Volt Large Size Variable.....	\$ 1.96			E-T 3-Circuit Transformers.....	
45-Volt Large Size Variable.....	3.89			2.94	
				Cosmopolitan Phisiformers.....	
				7.98	
				Peerless Tuning Coil.....	
				4.78	
PRICES F. O. B. ST. LOUIS, MO. All orders shipped same day received. Postage and insurance not included in prices. Send stamp for our list of 1000 barclains.					

# STAR-RITE RADIO BATTERIES SAVE YOU 50%

And Guarantee You in Writing 2 Years of Better Battery Performance

STAR-RITE RADIO BATTERIES are made especially for Radio and the big saving is made possible by coming direct to you instead of thru distributors, dealers, etc. Boxes are made of oak, finished in mahogany and the plates very thick and will give a steady discharge over a long period. No premiums, just good, honest battery value.

TRY TO BEAT THESE PRICES

2 Volt for W. D. 11 and 12.....	\$4.00	6 Volt 60 Ampr. ....	\$ 7.50
4 Volt for U. V. 199 Tubes.....	7.00	6 Volt 80 ".....	8.50
<b>RADIO B. STORAGE</b>		6 Volt 100 ".....	10.00
Glass Jars, Heavy Plates—		6 Volt 120 ".....	12.10
Case of 12 Cells, 24 V.....	4.90	6 Volt 150 ".....	14.00
		6 Volt 200 ".....	17.00

Get Yours Today—NOW—Send No Money

The batteries are fully guaranteed in writing and shipped subject to examination on the day your order is received. You pay on delivery or deduct 5 per cent if full cash accompanies order. You may deduct 10 per cent if two or more are ordered at one time.

## STAR-RITE BATTERY CO.

Department 5      LOUISVILLE, KY.



AN EVENING AT HOME WITH THE LISTENER IN (SEE INSTRUCTIONS FOR USE BELOW)

Table with columns for Station and City, Met., Monday, Tuesday, Wednesday, Thursday, Friday, Saturday, Sunday. Lists various radio stations and their broadcast times.

Instructions for Use.—All the hours above are given in Central Standard Time. If your city uses Eastern Time, add one hour to each of the periods stated; if your city uses Mountain Time, subtract one hour; if your city uses Pacific Time, subtract two hours. If in addition, your city uses daylight saving time, add one hour to this result. This table includes only the evening broadcasts, and, on Sunday, the late afternoon program.

Woodrow Wilson was the first president of the United States to have his voice sent through the ether. This event occurred July 4, 1919, when he was coming home from France on board the S. S. George Washington.

2-LO, LONDON, ENGLAND ON ONE TUBE

Another Record for the ELGIN SUPER-REINARTZ

Tuesday, November 27, during the test period between 9 and 9:30 P. M., Rev. E. A. Cole in the residence of J. A. McIver, of Roodhouse, Ill., while operating a set made of materials and in accordance with the hookup furnished by the ELGIN RADIO SUPPLY CO., tuned in 2-LO, London, England, using receivers and but one tube. Later another tube was lighted and the loud speaker used, so that four people could hear the program and concluding announcement. The numbers, time, and the order in which they were played were

Officially Confirmed

by the St. Louis Post Dispatch in conjunction with the National Association of Broadcasters, who had charge of the tests. (See page 34, St. Louis Post Dispatch, Dec. 2, 1923.) This same hookup has been advertised extensively as the one which brings in stations 2000 miles overland on a loud speaker and one tube; and this has been demonstrated so often as to need no repetition.

Send a two-cent stamp for circular giving one, two, and three tube hookup, and price list of parts for this remarkable circuit. Address the

ELGIN RADIO SUPPLY CO. 207 Chicago St. ELGIN, ILL.

KEEPS CONFIDENCE; JAILED; LISTENS IN



Ralph L. King, City Editor of Waukegan, Ill., Daily Sun, remained in touch with the news of the world despite the fact that he was in jail for having refused to tell a special grand jury his source of information regarding a news item which he printed concerning rumors of graft in North Chicago official circles. He states that he is happy though jailed for having upheld the traditions of journalism.

Thanks to Radio, He Says, He Has Plenty of Sugar

CHARDON, O.—If it hadn't been for Radio, Ambrose Davis of this city, wouldn't have fifty-eight gallons of Geauga county's choicest maple syrup safely stowed away, he declares. Davis didn't intend to make any syrup this year. The advance Radio weather reports savored so much of good sugar weather that he tapped his trees.

RELATES ORIGIN OF 'RED APPLE' NAME

Story About a Sunday School Teacher Gave Title to Detroit Midnight Show

DETROIT.—Who hit upon the "Red Apple Club" as the name for the "midnight show" given by WCX every Tuesday night? Here is a story as told by its chief, C. D. Tomy, who so often expresses his fondness for apple pies and doughnuts through the microphone:

"On a lovely mountain side out in Wyoming there is a plain marble shaft, erected to mark the last resting place of Grant Jones, newspaperman. Beneath the simple inscription might be added, 'Founder of the 'Red Apple Club.'"

"During the several years that Jones lived in Wyoming, he made a trip to Chicago each summer and the old gang gathered around to hear the fund of stories that were supposed to come out of the west, but in reality came from the imaginative brain of the narrator.

He Offers Red Apple Prize

"One story was a nonsensical tale of a Sunday School teacher, who for something or other, offered her pupils a prize of 'a nice red apple.' 'Chief' Tomy was in the party and listened, but the story was practically forgotten during the years that followed. Then one night more than a year ago the 'Chief' stood before the microphone in the Free Press studio and announced that there would be a prize for the one who could guess the name of the singer. Out of the subconscious mind that the highbrows write about came Jones and his 'nice red apple,' and so that was the prize offered.

"The name made a hit and naturally stuck to the midnight show. Who can tell! Maybe those Radio waves travel to that unknown land and Grant Jones listens in on Tuesday nights. He'd be strong for it."

Frequently an antenna supported by trees or other movable objects will sway in the wind. This will cause changes in its capacity, and give the effect of fading signals in the receivers.

De Forest Auditions are made by the man who invented broadcasting! DE FOREST RADIO TEL. & TEL. CO., Dept. R. D. 9, JERSEY CITY, N. J.

Coto 'Built First to Last' Stop the Leaks! Save all the energy in the antenna for your detector tube. This Coto Compact Air Condenser with Vernier is so perfectly insulated that losses are reduced to a minimum. Plates are of silver plated copper soldered in place for lasting adjustment. Type 3505 .0005 Mfd. \$5 Type 3518 .001 Mfd. \$6 COTO-COIL CO. 87 Willard Ave., Providence, R. I. BRANCH OFFICES: Los Angeles, 329 Union League Bldg.; Minneapolis, Geo. F. Darling, 705 Plymouth Bldg.; Atlanta, C. P. Atkinson, Atlanta Trust Co. Bldg.; CANADA, Perkins Electric Co., Ltd.; Montreal, Toronto, Winnipeg.







# SPECIAL BOYS' WEEK PROGRAM FROM

## Where to Hear Concerts

THESE are the stations for music lovers to dial, and you can hear, providing you dial correctly and read the programs carefully, everything from jazz to opera.

**Tuesday:** CKAC, CKY, KDKA, KFI, KFSG, KGO, KHJ, KPO, KSD, KYW, WAAM, WAAW, WBAH, WBAP, WBZ, WCAE, WCX, WDAF, WDAP, WDAY, WDFW, WFAA, WFI, WGI, WGY, WHAS, WHB, WIP, WJAX, WGN, WJY, WJZ, WLAG, WLW, WMAQ, WMC, WOAW, WOO, WOR, WSB, WTAS, WWJ.

**Wednesday:** CKAC, KDKA, KFAE, KFI, KFNF, KGW, KHJ, KPO, KSD, KYW, WAAM, WAAW, WBAP, WBZ, WCAE, WDAF, WDAY, WDFW, WFAA, WFI, WGAZ, WGI, WGN, WHAS, WHB, WIP, WJZ, WKAQ, WLAG, WLW, WMAQ, WOC, WOO, WOR, WOS, WSB, WTAM, WTAS, WWJ.

**Thursday:** CKAC, CKY, KDKA, KFI, KFKX, KFSG, KGO, KGW, KHJ, KLZ, KPO, KYW, WAAM, WBAH, WBAP, WBZ, WCAE, WCBZ, WCX, WDAF, WDAY, WDFW, WFAA, WFI, WGI, WGN, WGY, WHAS, WHB, WIP, WJAX, WJY, WJZ, WLAG, WLW, WMAQ, WOC, WOO, WOR, WOS, WSB, WRC, WTAS, WWJ.

**Friday:** CKAC, KDKA, KFAE, KFI, KFSG, KHJ, KGW, KPO, KSD, KYW, WBAH, WBAP, WBZ, WCAE, WCX, WDAF, WDAY, WDFW, WFAA, WFI, WGAZ, WGI, WGN, WHAS, WHB, WIP, WJAX, WJY, WJZ, WLAG, WLW, WMAQ, WOC, WOO, WOR, WOS, WSB, WTAS, WWJ.

WGN, WHAS, WHB, WHK, WIP, WJY, WJZ, WKAQ, WLAG, WMAQ, WMC, WOAW, WOC, WOR, WRC, WSB, WTAS, WWJ.

**Saturday:** CKAC, KDKA, KFI, KFNF, KFSG, KGO, KHJ, KPO, KSD, KYW, WBZ, WCAE, WCX, WDAF, WDAP, WDAY, WDFW, WFAA, WFI, WGI, WGN, WHAS, WHK, WIP, WJZ, WLAG, WMAQ, WMC, WOAW, WOC, WOR, WRC, WSB, WTAM, WTAS, WWJ.

**Sunday:** CKAC, CKY, KDKA, KFI, KFNF, KFSG, KGW, KPO, KHJ, KYW, WBAP, WCAE, WDAY, WDFW, WFAA, WGI, WGN, WGY, WHAS, WHK, WIP, WLAG, WLW, WOC, WSB, WTAS, WWJ.

**Monday:** CKAC, KDKA, WFAA, KFAE, KFI, KFKX, KFOA, KGW, KPO, WAAM, WAAW, WBAH, WBAP, WBZ, WCAE, WCBZ, WCX, WDAF, WDAY, WDFW, WFAA, WFI, WGI, WGN, WGY, WHAS, WHB, WIP, WJAX, WJY, WJZ, WLAG, WLW, WMAQ, WOC, WOO, WOR, WOS, WSB, WTAS, WWJ.

**Tuesday:** CKAC, CKY, KFSG, KGO, KPO, WBAP, WCX, WHAS, WOAW, WAAW, WDAF, WDAY, WFAA, WIP, WJAX, WLW, WGN, WGY, WOO, WOR, WRC, WSB, WTAS, WWJ.



Arthur Randall, director and pianist of Randall's Royal Orchestra of the Brandeis State Restaurants, is ranked as one of the best dance maestros in the middle west and is a composer and arranger of great note. The orchestra will play from WOAW, Monday evening from 6:30 to 7:30 p. m.



Louis Love, social service worker, has won a host of fans among the housewife listeners of WCX, Detroit, with her weekly talks. Mrs. Love's next talk will be "The Care of the Children" on Wednesday evening, April 30, at 4:30 p. m. Rosaline Green (right), the green-eyed, brown-haired, eighteen-year-old lead of the WGY players, will appear as "Lady Aetha Frohisher" in "The Walls of Jericho," which will be presented by the players from WGY, Schenectady, on Thursday evening, May 1.

### Wednesday, April 30

(Continued from page 15)

reporter; George W. Hood, reader; 8:00-9:00 program presented through courtesy of Mrs. J. F. Faber, presenting Hon. B. F. Biedsoe, U. S. Dist. Judge, speaker; Carl Buratti, cornetist; Robert Odell, president of the Board of Education, and Burkman Brothers Hawaiian Quartet; 9:00-10:00, Dr. Mars F. Baumgardt, lecturer; Appreciation program Mrs. Cecil Frankel, vice-president of the National Federation of Music; 10:00-11:00, Art Hickman's Dance Orchestra.

**KPO, San Francisco, Calif. (Pacific, 423), 1:00-2:00 p. m.,** Rudy Seiger's Fairmont Hotel Orchestra; 2:30-3:00, Jack Falt's Entella Cafe Orchestra; 4:30-5:30, Rudy Seiger's Fairmont Hotel Orchestra; 5:30-6:30, Children's hour, "Big Brothers" of KPO, Book of Knowledge; Joseph F. Burns, pianist; 7:00-7:30, Rudy Seiger's Fairmont Hotel Orchestra; 8:00-11:00, E. Max Bradford's Versatile Band.

**KSD, St. Louis, Mo. (Central, 548), 6:30 p. m.,** Program, Aberg's Concert Ensemble; 9:00, Studio recital, Mrs. H. W. Geller, soprano; Virginia Slack, reader; 11:00, Hotel Staller dance music.

**KYW, Chicago, Ill. (Central, Daylight Saving, 536), 11:35 a. m.,** Table talk, Mrs. Anna J. Peterson; 6:00 p. m., Spanish lesson, Prof. A. A. Braschi; 6:45, Children's bedtime story; 7:00, Dinner concert, Congress hotel, Joska DeBary's orchestra, Clyde Doerr's Orchestra; 8:00, Gwendie W. Evans, soprano; John Davies, tenor; Grace M. DeCosta, soprano; J. Soumehien, baritone; 9:00, "Good Roads," Chicago Motor Club; 9:05, Union Trust Co.; 9:15, Book reviews; Lewellyn Jones; 10:00-2:30 a. m., Midnight revue.

**WAAM, Newark, N. J. (Eastern Daylight Saving, 255), 7:00-7:30 p. m.,** "Star Spangled Banner," James P. Gregory's University Club; 7:30-7:45, Benj. Jacobs, tenor; Y. C. Police Dept. Glee Club; 7:45-8:00, Al Norins, tenor; Clinton Sommer, pianist; 8:00-8:15, Richard Douglas; 8:15-8:45, Ery Bradley's "Melody Boys"; 8:45-9:15, Stevens, Institute Glee Club; 9:15-9:45, Billy Berkes' Merry Manhattan Melodians; 9:45-10:00, Figures Famous in History; Thomas Paine—by Elizabeth Burt; 10:00-10:15, Al Wilson & James A. Brennan, composers; 10:15-10:45, Frederick and Viola C. Henze, Irish songs; 10:45-11:00, Weekly Grab-bag of Celebrities, directed by Leo Friedman; 11:00-11:15, "How Songs and Song Writers Become Famous," by Leo Friedman; 11:15-11:30, Jimmy Doyle and Geo. Roberts, song writing team.

**WBAH, Minneapolis, Minn. (Central, 417), 12:30-1:30 p. m.,** Dick Long's Trio and soloists; 7:00-7:30, Lectures, Dr. J. W. Holland.

**WBAP, Fort Worth, Texas (Central 476), 7:30-8:30 p. m.,** Concert, Tom Dawson's Mandolin Orchestra of Weatherford, Texas; 9:30-10:45, Concert, Dick Gaines Dance Orchestra.

**WBAY, Columbus, Ohio (Eastern, 390), 12:00 m.,** Piano music, Ila Lorbach Owens.

**WBZ, Springfield, Mass. (Eastern, Daylight Saving, 337), 6:00 p. m.,** Dinner concert, WBZ String Orchestra; Alice Co. Fred Rosenfeld, pianist; 7:30, Lecture, Major Charles A. Thuis; Letter from the New England Homestead; Hotel Kimball Studio; 7:30, Bedtime story for the Kiddies; 7:40, Chamber music, WBZ String Orchestra; Alice A. Mikus, harpist; Lenox Bigelow, baritone; Gertrude Clifford, soprano; Mrs. Eleanor T. LaZazzera, accompanist; 8:30, Program of music, Home Beautiful Exposition; 11:30, Dance music, Leo Reisman and His Orchestra.

**WCAE, Pittsburgh, Pa. (Eastern, Daylight Saving, 467), 3:30 p. m.,** Fred Rosenfeld, pianist; 4:30, Uncle Kaybee; 6:30, Dinner concert, William Penn Hotel; 7:30, The Sunshine Girl; 7:45, Theatrical review; 8:30, Musical program, Musical Club of Ellwood.

**WCX, Detroit, Mich. (Eastern, 517), 4:15 p. m.,** Musical program; 6:00, Dinner concert; 8:30, Musical program, Irena Schnickler Zierlyn, director.

**WDAF, Kansas City, Mo. (Central, 411), 3:30-4:30 p. m.,** Musical matinee, Geary's Missourians; 6:00-7:00, School of the Air; piano tuning-in number, Duo-Art; Address, speaker from the Health Conservation Association; The Tell-Me-a-Story Lady; Fritz Hamlein's Trio; 8:00-9:15 p. m., Program arranged and presented by the student department of the Associated Kansas City Music Clubs; 11:45 p. m., "Merry Old Chief" and the Coon-Sanders Orchestra, Hotel Muehlebach.

**WDAP, Chicago, Ill. (Central, Daylight Saving, 360), 7:00-8:30 p. m.,** Drake Concert Ensemble and Blackstone String Quintette; 10:00, John Stamford, Barton Organ, Ralph Emerson, Jack Chapman's Orchestra.

**WDAE, Philadelphia, Pa. (Eastern, Daylight Saving, 395), 11:45 a. m.,** Daily Almanac; 12:02 p. m., Organ recital, Stanley Theater; 12:30, Arcadia Cafe Concert Orchestra; 2:00, Arcadia Cafe Concert Orchestra; 4:30, Piano solos, Mrs. Louis Love, Edna Finestone, "Care of Children"; 7:30, Dream Daddy's bedtime stories; 8:00, Concert, Boys' West Philadelphia High School; 8:15, Talk, Alexander Colville, Jr.; 8:25, Boys' West Philadelphia High School; 8:40, Talk, Henry M. Neely; 8:50, Baseball talk, Eddie Romer; 9:15, Philadelphia Athletic pitcher; 10:10, Howard Lar. A. ad'a Cafe Dance Orchestra.

**WEAF, New York, N. Y. (Eastern, Daylight Saving, 492), 11:15 a. m.,** Vee Lawnhurst, pianist; 11:30, Talk on "Mothers"; 11:45, N. Y. Tuberculosis Society; 12:00 noon, Chapel Service from Columbia University; 4:00 p. m., Muriel Muth, popular songs; 4:10, Hazel Wedel, pianist; 4:30, Teresa Uhlinger, entertainer; 4:50, Classical Trio; 7:00, Synagogue Services; 7:30, Thomson Fisher; 7:50, American Agriculturist; 8:00, Columbia University; 8:20, Bridgeport Oratorio Society; 9:30, Catholic Club of New York City; 10:15, Wendell Hall.

**WEAO, Columbus, Ohio (Eastern, 360), 1:30 p. m.,** Garden talk; 4:00, Agricultural lecture; Ohio State University faculty member; Music, university talent.

**WFAA, Dallas, Texas, (Central, 476), 12:30-1:00 p. m.,** Musical recital, The Red-Headed Girl.

**WFI, Philadelphia, Pa. (Eastern, Daylight Saving, 385), 1:00 p. m.,** Meyer Davis Bellevue Stratford Concert Orchestra; 3:00, Piano solos, Loretta Kerk; 6:00, Sunny Jim, the Kiddies' Concert Orchestra; 6:30, Meyer Davis Bellevue Stratford Concert Orchestra.

**WGI, Medford Hills, Mass. (Eastern, Daylight Saving, 360), 12:00 m.,** Selections on the Ampico in the Chattering; Miss Drew's Ten Minutes; Selections on the Brunswick; 7:00 p. m., Meeting of the Big Brother Club; Message to Camp Fire Girls, Charles W. Casson, "Big Smoke"; 7:30, "Nerves," Rev. D. M. Heald; Waltham News Tribune Night; Popular song hits, Jack Nelson Pub. Co.; Don Ramsey, pianist.

**WGN, Chicago, Ill. (Central, Daylight Saving, 370), 7:00-8:00 p. m.,** Address, Ida Maitland, cellist; Oriole Orchestra; 9:00-11:00, William Balhatchet, tenor; Ukelele Trio; Edward Jenkins, pianist; Oriole Orchestra; 12:00 midnight, Midnight program, Dr. Donald B. MacMillan and His Crew.

**WGR, Buffalo, N. Y. (Eastern, Daylight Saving, 319), 12:30-1:00 p. m.,** George Albert Bouchard, organist; 7:30-8:00, The Radio Dealers Musical Program; 6:30-7:30 and 11:30, Vincent Lopez Hotel Staller Orchestra; 8:50-9:00, Address, "Investments," Walter Delaplante; 9:00-10:30, Concert, American Artists Club, direction, A. A. Van der Mark; 10:30-10:45, Address, "Eliminating Unnecessary Fatigue in Industry," Frank E. Gilbreth, Montclair, N. J.; 10:45-11:00, Concert, Lafayette Novelty Boys' Orchestra.

**WGY, Schenectady, N. Y. (Eastern, 380), 5:30 p. m.,** "Adventure Story," Youth's Companion.

**WHA, Madison, Wis. (Central, 360), 7:30 p. m.,** "The Progress of Alfalfa," W. W. Clarke.

**WHAS, Louisville, Ky. (Central, 400), 4:00-5:00 p. m.,** Walnut Theatre Orchestra; Selections Alamo Theater organ; 7:30-9:00, Concert, Keith Kennard and his Kentucky Ramblers; Agricultural Tabloid talk; Reading, An Interesting Historical Episode.

**WHB, Kansas City, Mo. (Central, 411), 12:35-1:00 p. m.,** Popular program, Sweeney Radio Orchestra; 2:00-3:00 p. m., Ladies' hour program, Sweeney Radio Orchestra; 7:00-8:00 p. m., Orchestra numbers, Sweeney Radio Orchestra; Vocal duet, Edna Groneweg, Viola Sigma.

**WHN, New York, N. Y. (Eastern Daylight Saving, 360), 2:15-2:30 p. m.,** Ben Jacobs tenor Police Glee Club; 2:30-2:45, Berta Gilbert of the Beau Arts; 2:45-3:15, Fred Whitehouse, Revue; 3:45-4:15, Victor Wilbur and Jos. Macey, songsters; 4:15-4:30, The Love Twins from the Monte Carlo; 4:30-5:00, Brassfields De Luxe Orchestra; 5:05-5:30, The Tangoland Serenaders; 7:30-7:55, Mal Hallett's Roseland Dance Orchestra; 8:00-8:30, London Shoe Orchestra and Entertainers; 8:30-8:50, Union of Orthodox Jewish Congregations presenting Dr. Samuel Nirenstein; 8:50-9:00, H. Murray O'Neil, baritone; 9:00-9:30, Dan Gregory and His Dancing Carnival Orchestra; 9:30-10:00, M. Wittmark Black and White program; 10:05-10:30, Fletcher Sanderson's Alabama Club Orchestra.

**WIP, Philadelphia, Pa. (Eastern, Daylight Saving, 369), 1:00 p. m.,** Gimbel Brothers' Tea Room Orchestra; 3:00, Piano recital, Emilie Loeben; 7:00, Uncle Wip's bedtime stories.

**WJZ, New York City, N. Y. (Eastern, Daylight Saving, 445), 1:00 p. m.,** Schrafft's Tea Room Orchestra, Director Michael Anselmo; 3:00, Ida Davenport, soprano; 3:45, Ethel Fay, pianist; 4:00, Eleanor Gunn's Fashion Talk; 4:10, Charlotte Modersohn, soprano; 4:30, Tea Concert, Hotel Commodore Orchestra, Bernhard Levitov, director; 7:30, Irving Selzer and His Cafe Boulevard Orchestra; 8:00, Dance Program, Boulevard Orchestra, Irving Selzer, director; 9:05, Annual Banquet, Talking Machine and Radio Men Association, Paul Whiteman; Garber Davis; Piron Orchestra; Brooke Johns; Brox Sisters; Vincent Lopez, Ben Selvin, Emil Coleman, Paul Specht, Eddie Cantor.

**WKAQ, San Juan, P. R. (Intercolonial, 360), 8:00 p. m.,** Municipality Band of San Juan.

**WLAG, Minneapolis-St. Paul, Minn. (Central, 417), 10:45-11:15 a. m.,** Household Hints; 11:35-12:00 m., Surprise Hour; 2:00-2:30 p. m., "Radio Sewing Lesson," Mme. Myrtle Saperston; "Development of Kindergarten Ideas," Elizabeth Hall; 2:40-4:00, Daylight Concert, Chi Chapter of Sigma Alpha Iota, National Musical Sorority at Macalester College; 4:00-4:30, Magazine Reading; 5:30-6:00, Children's Stories, Mrs. Robert Carlgill; 6:00-6:30, Sport Hour, "Talk," Carl, St. Louis; 7:30-8:15, Farm lectures, "Basic Principles of Heredity," Fred Griffies; "Raccoon Farming," James Dunn White Bear, Minn.; 9:30, Program, St. Peter, Minn. Business Men's Association.

**WMAQ, Chicago, Ill. (Central, Daylight Saving, 447.5), 1:00 p. m.,** Speeches, Chicago Association of Commerce; 2:35, Lyon & Healy program; 4:20, Items of interest to women; 4:30, Pupils, Cosmopolitan School of Music; 7:00, Georgene Faulkner, story lady; 7:30, Weekly lecture, Northwestern University; 8:00, Play, Chicago Rotary Club; 8:40, LaSalle Hotel Orchestra; 9:00, Talks, Chicago charities; 9:15, Farnham Trio; Mrs. Faye W. Gettrust.

**WOC, Davenport, Iowa (Central, 484), 12:00 m.,** Chimes; 3:30 p. m., "Bancroft's The Revolutionary Alarm"; C. A. Russell; 6:30, Sandman's visit; 7:00, "Building an Automobile for the Public"; H. C. Snow; 8:00, Organ recital, Erwin Swindell; Viola Houston; Madeleine Kneberg.

**WOD, Philadelphia, Pa. (Eastern, Daylight, 509), 11:00 a. m.,** Organ recital, Mary E. Vogt; 12:02 p. m., Wanamaker Crystal Tea Room Orchestra; Robert E. Golden, director; 4:45, Organ recital, Mary E. Vogt; 7:30, Havana Casino Orchestra from Sylvania Hotel; 8:30, WOO Orchestra, Robert E. Golden, director; 10:03, Hotel Adelphia Dance Orchestra.

**WOO, Kansas City, Mo. (Central, 360), 3:00-3:30 p. m.,** Music, Wurlitzer Reproducing Piano; 8:00-9:30 p. m., Popular music, Hanley's Radio Shop; Paul Hickman's Orchestra; Hallet and Fleming, vaudeville entertainers.

**WOR, Newark, N. J. (Eastern, Daylight Saving, 405), 2:30-2:45 p. m.,** Radioling New Jersey Traditions"; by Ernest A. Reed; 2:45-3:00, Arline Felker, soprano, accompanied by Elicanor Nelson; 3:00-3:15, Marion Estell, Adam, con.; 3:30-3:45, Arline Felker; 3:45-4:00, Marion Estelle Adam; 6:15-6:30, "Music While You Dine," Ernie Kirckel's Paramount Records Orchestra; 9:15-9:30, Lilyan May Challenger, con.; 9:45-10:00, Lilyan May Challenger; 10:15-11:00, Concert by the Arcadian Orchestra.

**WOS, Jefferson City, Mo. (Central, 440.9), 8:00 p. m.,** "The Control of Truck Crop Pests and the Control of Rodents," Otis Wade; 8:20, Old time fiddling program, String Band from Lupus, Will Hickman, first fiddler; Robert Moore, second fiddler; Luke Peterson, bass fiddler; Jack Hickam, banjoist; Joe Hickam, guitarist.

**WRC, Washington, D. C. (Eastern, 469), 3:00 p. m.,** Fashion Developments of the Moment, Women's Wear; 3:10, Song recital; 3:30, Housekeeper's half hour, Aunt Margaret; 3:45, Eleanor Glynn, pianist; 3:50, Current topics, editor of The Outlook; 4:00, Song recital; 6:00, Stories, Peggy Alphon.

**WSE, Atlanta, Ga. (Central, 429), 10:45 p. m.,** Home talent entertainment.

**WTAM, Cleveland, Ohio (Eastern, 390), 8:00 p. m.,** Selections, The WTAM Symphony Orchestra, assisted by West End Garage Co. Saxophone Seneraders of New Philadelphia, Ohio, and Glenville Baptist Church Choir, Baritone solos, Charles Murray, Georgia Hall, accompanist; Clarinet solos, Oscar Puigner, Alice Murray, accompanist; Bass solos, J. Fenimore Helmick, Alice Murray, accompanist; Instrumentalist, Saxophone Quartet, Edwin Kinsey, Howard Ulrich, Frank McCarty, Everett Dienst; Soprano solo, Virginia Huffman; Choral selection, Glenville Baptist Church Choir, Mrs. Ira N. Clover, accompanist; Soprano solos, Helen Milmine, Dorothy McLean; Tenor solos, C. F. Kibby; Trumpet solos, Alois Hruby; Soprano solos, Gladys Koepfert, Mrs. Ralph Trinker, Emmaetta Friedel; Vocal solos, H. T. Roper, John Hutton Chas. F. Gardner; Male chorus, members Glenville Baptist Church Choir.

**WVJ, Detroit, Mich. (Eastern, 517), 8:00 a. m.,** Setting-up exercises, R. J. Horton; 12:00 m., Goldkette's Orchestra; 3:00 p. m., Detroit News Orchestra; 7:00, Detroit News Orchestra; Vocal numbers, pupils of Marlon Barkume.

### Thursday, May 1

**CKAC, Montreal, Can. (Eastern, 425), 7:00 p. m.,** Kiddies' stories in French and English; 7:30, Rex Battle and His Mt. Royal Hotel Concert Orchestra; Benjamin Seberzer, violinist; Rex Battle, pianist; 8:30, Basilica Choir; A. Letondal, organist; 10:30, Joseph C. Smith and His Mount Royal Hotel Dance Orchestra; Specialties, Teddy Brown.

**CKY, Winnipeg, Can. (Central, 450), 8:00 p. m.,** Canadian National Railway program.

**KDKA, E. Pittsburgh, Pa. (Eastern, 326), 5:30 p. m.,** Dinner concert, KDKA Little Symphony Orchestra; 6:30, Mother Goose Will Have Her May Party; 7:15, Program, National Stockman and Farmer; "Animal Quarantine and Regulatory Activities of the U. S. Department of Agriculture," Dr. W. T. Conway; "King Corn," E. J. Walter; "Farm Finance," W. A. Royston, Jr.; 8:00, Concert, Chauncey Parson; 11:00, Special concert.

**KFI, Los Angeles, Calif. (Pacific, 469), 6:45-7:30 p. m.,** Concert by Y. M. C. A., and Sales lecture; 8:00-9:00, Ambassador Hotel concert; 9:00-10:00, Examiner concert; 10:00-11:00, Instrumental and vocal concert presented by the George J. Rinkel Music Company.

**KFKX, Hastings, Neb. (Central, 341), 9:30 p. m.,** Talent, Hildreth.

**KFNF, Shenandoah, Iowa, (Central, 266), 7:30 p. m.,** Concert, Elk's Band of Shenandoah, under direction of Harry Day.

**KFSG, Los Angeles, Calif. (Pacific, 278), 3:30-4:30**

p. m., Organ recital through courtesy of Prof. Wm. Kraft, B. E. Ballard and Jean de Chauvent; 6:30-7:00, Children's hours; Bible stories by Mrs. M. Kennedy; 8:00-8:25, Boy talks, Thomas B. Brown, Boy Scout Commander; 8:25-9:15, Revival Services conducted by Aimee Semple McPherson; 9:15-10:00, Special concert program presented by students of Echo Park Evangelistic and Missionary Training Institute and Angelus Temple Choir of sixty voices; 10:02-10:10, The Family Altar and Prayer conducted by Aimee McPherson; The Angelus Temple Chimes will sign off KFSG.

**KGO, Oakland, Calif. (Pacific, 312), 8:00 p. m.,** "Daddy-Long-Legs," KGO Players, Cast: Jervis Pendleton, Roger Noble Burnham; James McBride; Richard Ehlers, Cyrus Wykoff, J. Spencer Riley; Abner Parsons, David Barnwell, Griggs, Conrad Kahn, Walters, Gerald Malsby; Judy, Rose Brown; Miss Pritchard, Vera Morse; Mrs. Pendleton, Evelyn Avery; Julia Pendleton, Mary Miller; Sallie McBride, Lenore Everett; Mrs. Semple, Mary Harper; Mrs. Lippett, Mrs. Palmer; Orphan Children at the John Grier Home; Sadie Kate, Roberta Hort; Gladia, Helen Barton; Loretta, Jane Barker; Mamie, Ruth Mason; Freddie Perkins, Barnston Smeaton; Claremont Orchestra.

**KGW, Portland, Ore. (Pacific, 429), 12:30 p. m.,** Concert, Seiberling Lucas Music House; 3:30, Woman's story program, installment of "The Midlander"; 8:00, Accordion solos, Johnny Sylvester; 8:15, Dance music, George Olsen's Metropolitan Orchestra; 10:00, Dance music, George Olsen's Metropolitan Orchestra; Naomi Miller, soprano.

**KHJ, Los Angeles, Calif. (Pacific, 395), 12:30-1:15 p. m.,** Vocal and instrumental concert; 2:30-3:30, Program presented through courtesy of Barker Brothers; 6:00-6:30, Art Hickman's Concert Orchestra; 6:30-7:30, Music Memory Contest, conducted by Fitzgerald Music Co. "Stories of American History," Prof. Walter Sylvester Hertzog, The Hollywood School for Girls Glee Club; Weekly visit of Dickie Brandon, silver-sheet juvenile; Bedtime story, "Uncle John"; 8:00-9:00, Program, Fitzgerald Music Co.; 9:00-10:00, Albert Bryant, tenor; Susan Francis White, reader; 10:00-11:00, Art Hickman's Dance Orchestra.

**KPO, San Francisco, Calif. (Pacific, 423), 1:00-2:00 p. m.,** Rudy Seiger's Fairmont Hotel Orchestra; 2:30-3:30, Organ recital, Theodore J. Irwin; 4:30-5:30, Rudy Seiger's Fairmont Hotel Orchestra; 5:30-6:30, Children's hour, "Big Brother," Book of Knowledge; 7:00-8:00, Rudy Seiger's Fairmont Hotel Orchestra; 8:00-9:00, Philp Lombardi, Argentine tenor; Sylvia Regl, accompanist; 9:00-10:00, Sue Hill, soprano; Mildred Stombs, accompanist; Ethel Guyon, fustist; 10:00-11:00, E. Max Bradford's Versatile Band.

**KYW, Chicago, Ill. (Central, Daylight Saving, 536), 11:35 a. m.,** Table talk, Mrs. Anna J. Peterson; 2:35 p. m., Studio program; 6:45, Children's bedtime story; 7:00, Dinner concert, Joska DeBabary's Orchestra; Paul Whiteman's Celebrated Collectians; 7:35, Sport talk, Leo Fisher; 7:45, Talk on "Finance and Markets," T. Hoyme; 8:00, "Twenty Minutes of Good Reading," Rev. C. J. Perlin; 8:20-8:50, Edison Symphony Orchestra; 9:20, Sandy Meek, tenor, Harry C. Geske, pianist.

**WAAM, Newark, N. J. (Eastern, Daylight Saving, 255), 7:00-7:45 p. m.,** "Star Spangled Banner," Wayne Bidewell's Melody Ramblers; 7:45-8:00, Lillian Spitzer, pianist; 8:00-8:15, The Best of Current Motion Pictures, Alice B. Evans of Natl. Committee for Better Films; 8:15-8:30, Margulies Trio; 8:30-8:45, Lyon Menerson of Metropolitan Magazine, Talk on Writing Successfully for the Magazines; 8:45-9:00, Maurice Snoch, Belgian lyric tenor; 9:00-9:15, Harry Romaine, tenor, Dorothy Mack, pianist; 9:15-9:30, Rev. Dr. Arthur W. Brooks, astrologist; 9:30-1:00, Cou Conrad and Fritz Letton; 10:00-11:00, Chas. J. Sanders' Sterling Dance Orchestra; 11:00-11:15, Chas. Wilson McGovern, tenor.

**WAAW, Omaha, Neb. (Central, 360), 8:00 p. m.,** Educational program; Talk, W. J. Martin, assistant supervisor, agricultural department, Union Pacific System; Next Sunday's Sunday School lesson, Rev. Edgar Marshall Brown; "Getting Your Money out of a Loan Whenever You Want It," by P. P. Purdum.

**WBAH, Minneapolis, Minn. (Central, 417), 12:30-1:30 p. m.,** Dick Long's Trio and soloists; 2:35-3:15, Firmen's Saxophone Sextette.

**WBAP, Fort Worth, Texas, (Central, 476), 7:30-8:30**



# AAW; BURLESQUE SHOW FROM WSB



On April 29, Edgar Guest, the well-known poet, will delight the listeners of WCX, Detroit, with a program of his poems.

## Where to Hear Talks

TALKS, instructive, serious, humorous and even frivolous, are broadcast daily and below are listed the stations.

**Tuesday:** CKY, KDKA, KFAE, KFSG, KGW, KYW, WAAM, WCAE, WDAF, WDR, WDAF, WFAA, WGI, WGY, WHB, WIP, WJY, WJZ, WLAG, WMAQ, WMC, WOC, WSB.

**Wednesday:** KDKA, KFAE, KFSG, KFOA, KGO, KGW, KHJ, KPO, KYW, WAAM, WBAH, WBZ, WDAF, WDR, WDAF, WEAQ, WGI, WHA, WJZ, WLAG, WMAQ, WOC, WOR, WOS.

**Thursday:** KDKA, KFSG, KYW, WAAW, WAAM, WAAW, WBZ, WCAE, WDAF, WDR, WDAF, WEAQ, WEAQ, WFAA, WGY, WHAA, WHAS, WHB, WIP, WJAX, WJY, WJZ, WLAG, WLW, WMAQ, WOC.

**Friday:** CKY, KDKA, KFAE, KFOA, KFSG, KGW, KHJ, KLZ, KYW, WAAW, WBZ, WDAF, WIAO, WFAA, WGI, WGY, WHA, WHB, WIY, WJZ, WLAG, WLW, WMAQ, WOC, WOS.

**Saturday:** KDKA, KYW, WBAH, WBAP, WDAF, WFAA, WFI, WGI, WHAA, WIP, WLAG, WMC, WOAW, WOC.

**Monday:** CKY, KDKA, KFAE, WAAM, WBZ, WDAF, WFAA, WGR, WGY, WHAZ, WIP, WLAG, WOC.

**Tuesday:** KFSG, WDAF, KGW, WHAA, WHB, WIP.

## Friday, May 2

Concert, Owen Crockett's Yeoman Orchestra 9:30-10:45, Concert, Old Time Fiddlers of Lewisville, Texas.

**WBAV, Columbus, Ohio (Eastern, 390), 12:00 m.,** Religious Service, Columbus Council of Churches, Rev. Charles F. Bowman, pastor Mt. Vernon M. E. Church.

**WBZ, Springfield, Mass. (Eastern, Daylight Saving, 337), 6:00 p. m.,** Dinner concert, Leo Reisman Ensemble; 7:30, Bedtime story for the Kiddies; 7:40, Music, Home Beautiful Exposition; 8:00, Program, Methodist Episcopal Church; 9:30, Charise La Priere, pianist; Mardis Grown, baritone; Vincenzo Spolzinio, tenor.

**WCAE, Pittsburgh, Pa. (Eastern, Daylight Saving, 462), 4:30 p. m.,** The Sunshine Girl; 6:30, Dinner concert, William Penn Hotel; 7:30, Uncle Kaybee; 8:30, Romany Dance Orchestra; 11:00, Late concert, Boyd's Cameo Six Orchestra.

**WCX, Detroit, Mich. (Eastern, 517), 2:20 p. m.,** Sunday School lesson, Rev. Galus Glenn Atkins; 4:15, Musical program; 6:00, Dinner concert; 8:30, Musical program.

**WDAF, Kansas City, Mo. (Central, 411), 3:30-4:30 p. m.,** Musical matinee, D. Ambert Haley's Dance and Concert Orchestra; 6:00-7:00 p. m., School of the Air; Piano tuning-in number, Duo-Art; Address, speaker from the William Jewell College; Reading, Cecile Burton, from the works of local and Missouri writers; The Tell-Me-a-Story Lady; Fritz Hanlein's Trianon Ensemble, Hotel Muehlebach; 11:45 p. m., 1:00 a. m., Nighthawk Frolic, the "Merry Old Chief", and the Coon-Sanders Orchestra, Hotel Muehlebach.

**WDAP, Chicago, Ill. (Central, Daylight Saving, 360), 7:00-8:00 p. m.,** Drake Concert Ensemble and Blackstone String Quintette; 8:00-8:30, Barton Organ played by Ralph Emerson; 10:00, Program furnished by John Loring Cook, Jack Chapman's Orchestra.

**WDR, Philadelphia, Pa. (Eastern, Daylight Saving, 395), 11:45 a. m.,** Daily Almanac; 12:02 p. m., Organ recital, Stanley Theater; 12:30, Arcadia Cafe Concert Orchestra; 2:00 p. m., Arcadia Cafe Concert Orchestra; Weekly "Market Basket Talk" by Mrs. Anna B. Scott; 7:30, Dream Daddy's bedtime stories.

**WEAF, New York, N. Y. (Eastern, Daylight Saving, 492), 11:20 a. m.,** Talk on "Spring Dresses"; 11:30, Talk on "Blue Ribbon Mayonnaise"; 4:00 p. m., American Child Health Association; 5:00, Children's Hour program; 7:00, N. Y. Federation of Churches; 7:30, Thornton Fisher; 7:50, Bank of America; 8:00, Chiclet program; 9:00, Amphion Male Quartette; 9:30, Adelaide Soper, contralto; 10:00, Joseph Wilberscheid, violinist; 10:30, Harriet Sammet, pianist; 11:00, Vincent Lopez Orchestra.

**WEAO, Columbus, Ohio (Eastern, 360), 1:30 p. m.,** Garden talk; 8:00 p. m., Program, music group of University Women's Glee Club.

**WFAA, Dallas, Tex. (Central, 476), 12:30-1:00 p. m.,** Address, Dr. A. D. Laugenour, president, Dallas Astronomical Society; 6:45-7:00, Boy Scout program; H. W. Wester, Scout executive; 8:30-9:30, Musical program, Greenville, Tex., Male Quartet; 11:00-12:00, Recital, Gibson Mandolin and Guitar Club.

**WFI, Philadelphia, Pa. (Eastern, Daylight Saving, 395), 1:00 p. m.,** Meyer Davis Bellevue Stratford Concert Orchestra; 3:00, WFI Quartette; 6:00, Sunny Jim, the Kiddies' Pal, songs by George O'Hara; 6:30, Meyer Davis Bellevue Stratford Concert Orchestra; 8:00, Boy Scouts Radio Corps, supervision Boy Scouts of America; 10:10, Charlie Kerr and His Symphonic Dance Orchestra from Majestic Hotel.

**WGI, Medford Hillside, Mass. (Eastern, Daylight Saving, 360), 12:00 m.,** Selection on the Ampico in the Chickering; Miss Drew's Ten Minutes; Selections on the Brunswick; 7:00 p. m., Meeting of the Amrad Big Brother Club; 7:30, Talk Geoffrey L. Whalen, "The Radio Movie Man"; Musicals; Popular song hits, "Bernie and his Bunch."

**WGN, Chicago, Ill. (Central, Daylight Saving, 370), 7:00-8:00 p. m.,** Address, Lucille Walker, pianist; Oriole Orchestra; 9:00-11:00, Program, Blanche Blood's studio, Anna Lawrence, violinist; William Switzer, pianist; Olga Pica, violinist; Minnie Lee, pianist; Chris Fehrenbacher, violinist; Bessie Kohlmann, pianist; Lillian Houser, violinist; Margaret Nell, pianist; Rose Lawrence, violinist; Oriole Orchestra.

**WGR, Buffalo, N. Y. (Eastern Daylight Saving, 319), 12:30-1:00 p. m.,** George Albert Bouchard, organist; 2:30-4:00, The Radio Dealers Musical Program; 6:00-7:30, Chamber Music Recital.

**WGY, Schenectady, N. Y. (Eastern, 380), 1:00 p. m.,**

Dance program, The Better 'Ole Orchestra; 9:00, Talk on motoring, American Automobile Association; 9:15, Song recital; 9:30, Negro imitations, Arthur B. Pierce; 9:45, Song recital; 10:00, Operalogue, Peggy Albion, Washington Opera Company.

**WSB, Atlanta, Ga. (Central, 429), 8:00-9:00 p. m.,** Mayday concert, Athens; 10:45, Dr. Charles A. Sheldon, organist.

**WWJ, Detroit, Mich. (Eastern, 517), 8:00 a. m.,** Setting-up exercises, R. J. Horton; 12:00 m., Edward Barnes, baritone; LeRoy DeTurk, tenor; 3:00 p. m., News Orchestra; 7:00, Detroit News Orchestra; Victoria Davis, contralto; Irene Benson, soprano.

**CKAC, Montreal, Can. (Eastern, 425), 1:45 p. m.,** Mt. Royal Hotel Concert Orchestra; 4:30, Mt. Royal Hotel Dance Orchestra.

**CKY, Winnipeg, Can. (Central, 450), 1:00 p. m.,** Lecture, Professor, Agricultural College; 8:45, Lecture, Professor, University of Manitoba.

**KDKA, E. Pittsburgh, Pa. (Eastern, 326), 5:30 p. m.,** Organ recital, Paul Fleeper; 6:30, "The Queen of Hearts, She Baked Some Tarts"; 7:05, Radio Boy Scout meeting; 8:00, Special feature.

**KFAE, Pullman, Wash. (Pacific, 330), 7:30 p. m.,** "Babylon's Orchestra," Leighton, "Farm Crops," C. L. Vincent, "Is the Pacifist Right?" Rev. Clay Palmer; William P. Hanson, cornetist; "Transferring Bees," B. A. Sloucum; "Highways of the Northwest and Their Condition," H. E. Phelps; Book chat, Alice Webb.

**KFI, Los Angeles, Calif. (Pacific, 469), 6:45-7:30 p. m.,** Concert program; 8:00-9:00, Evening Herald concert; 9:00-10:00, Examiner concert; 10:00-11:00, Concert of vocal and instrumental numbers; 11:00-12:00, Ambassador-Max Fischer Coconut Grove Orchestra.

**KFKX, Hastings, Neb. (Central, 341),** Rebroadcasts program of KDKA.

**KFOA, Shenandoah, Iowa (Central, 266), 7:30 p. m.,** Music, Legion Minstrel Orchestra of Shenandoah.

**KFOA, Seattle, Wash. (Pacific, 455), 8:30 p. m.,** Classical recital, James Hamilton Howe, director, Maude Pederson, Claire Turner, Mrs. Florita Munson-Wroten, Corinne Munson, Jean Black, Frank Burns, George McElroy, Mrs. Clifton Reid, L. F. Jones, Roy Deaver, Hazel Cameron, Ray Marston.

**KFSG, Los Angeles, Calif. (Pacific, 278), 3:30-4:30 p. m.,** Special musical program arranged and presented by Gladwyn N. Nichols, musical director of Angelus Temple; 6:30-7:00, Children's hour, Mrs. M. Kennedy, will review the International Sunday School lesson for May the 4th; 8:00-9:15, Regular weekly revival service conducted by Almee Temple McPherson; 9:15-10:00, The Angelus Temple Band and Crusaders will broadcast a special musical concert program; 10:02-10:10, The Family Altar and prayer conducted by Almee Temple McPherson; The Angelus Temple Chimes will ring off KFSG.

**KGW, Portland, Ore. (Pacific, 492), 12:30 p. m.,** Peck Holtou's Orchestra; 3:30, "Who Notched the Coat Lapel?"; 8:00 Lecture, Portland School of Social Work; 10:30, Hoop Owls.

**KHJ, Los Angeles, Calif. (Pacific, 395), 12:30-1:15 p. m.,** Program presented through courtesy of Barker Brothers; "Traffic Talk," Captain W. F. Cannon; 2:30-3:30, Program presented through courtesy of Barker Brothers; 6:00-6:30, Art Hickman's Concert Orchestra; 6:30-7:30, Music Memory Contest conducted by Fitzgerald Music Company; Prof. Walter Sylvester Hertzog, speaker; Program presented through courtesy of Barker Brothers; Weekly visit of Richard Headrick, silver-sheet juvenile; Bedtime story, "Uncle John"; 8:00-10:00, Program presented through courtesy of Barker Brothers; 10:00-11:00, Art Hickman's Dance Orchestra.

**KPO, San Francisco, Calif. (Pacific, 423), 1:00-2:00 p. m.,** Rudy Seliger's Fairmont Hotel Orchestra; 2:30-3:30, Organ recital, Theodore J. Irwin; 4:30-5:30, Rudy Seliger's Fairmont Hotel Orchestra.

**KSO, St. Louis, Mo. (Central, 546), 8:00 p. m.,** Program to be announced.

**KYW, Chicago, Ill. (Central Daylight Saving, 536), 11:35 a. m.,** Table talk, Mrs. Anna J. Peterson; 6:00 p. m., Spanish lesson, Prof. A. A. Braschi; 6:45, Children's bedtime story; 7:00-7:30, Dinner concert, Joska DeBabary's Orchestra; Paul Whitman's Celebrated Collegians; 8:20-8:30, Program, American Farm Bureau Federation; 10:00-2:30 a. m., Midnight revue.

**WAAW, Omaha, Neb. (Central, 360), 7:30 p. m.,** Boy's Day in the Home program arranged by Judge L. B. Day of Court of Domestic Relations.

**WBAA, Minneapolis, Minn. (Central, 417), 12:30-1:30 p. m.,** Dick Long's Trio and soloist; 7:00-7:30, Program, International Bible Students.

**WBAP, Fort Worth, Texas, (Central, 476), 7:30-8:30 p. m.,** Concert, Texas Christian University under arrangement of Prof. H. D. Guelck; 9:30-10:45, Concert, Fred Wagner and Hawaiian Steel Guitar Players.

**WBAV, Columbus, Ohio (Eastern, 390), 12:00 m.,** Piano music, Ila Lorbach Owens; 8:00 p. m., Concert, Otterbein College talent; Talk, President W. G. Clippinger; Men's Glee Club; A. R. Spessard, baritone; C. J. Broadhead and Glean Grant, Grabbill, pianists; Prof. C. A. Fritz, reader; Otterbein Banjo Orchestra.

**WBZ, Springfield, Mass. (Eastern, Daylight Saving, 337), 6:00 p. m.,** Dinner concert, WBZ Orchestra; 7:00, "The Pouch"; Youth's Companion; 7:30, Bedtime story for the Kiddies; 10:00, Program, Aaron Richmond, director; 11:00, Chamber music, WBZ Orchestra; Mrs. Gerku, contralto; Louis Bedard, violinist; Mrs. Ruby Tilton Kingsley, accompanist.

**WCAE, Pittsburgh, Pa. (Eastern, Daylight Saving, 462), 4:30 p. m.,** Special children's program, The Sunshine Girl and Uncle Kaybee; 6:30, Dinner concert, William Penn Hotel; 7:30, Uncle Kaybee; 8:30, Musical program, First Baptist Sunday School Orchestra of New Kensington.

**WCX, Detroit, Mich. (Eastern, 517), 4:15 p. m.,** Musical program; 6:00, Dinner concert; 8:30, Music, Caravan Club, Moslem Temple, Order of Mystic Shrine.

**WDAF, Kansas City, Mo. (Central, 411), 3:30-4:30 p. m.,** Musical matinee, Itquest program, the Leo R. Davis Orchestra; 6:00-7:00 p. m., School of the Air; Piano tuning-in number, Duo-Art; Address, speaker from the Kansas City Children's Bureau; Address, Fred Garner, second of a series on "Radio"; The Tell-Me-a-Story Lady; Fritz Hanlein's Trianon Ensemble; 8:00-9:15, Program arranged, Mrs. Ella

(Continued on page 18)









road-

WPAE,  
KLZ,  
WEAO,  
WHB,  
MAQ.

BAH,  
WGI,  
OAW,

WPAE,  
FAA,  
LAG,

KGW,

Nighthawk  
Gou-Sanders  
aving, 360),  
and Black-  
Sisters,  
lalph Emer-

ght Saving,  
p. m., Or-  
Radio Cafe  
Concert Or-  
ories, 8:00,  
R. Players,  
nce Orchest-  
ing Glory  
n Philadel-

ght Saving,  
Talk, "T. e  
estra; 5:15,  
y Clarence  
don Fi-ber,  
andy Fr-  
0, Battery  
tra; 10:  
ette,  
30 p. m.,  
Ohio Sta e  
city talet  
1:00 p. m.,  
00, "Aae-  
8:30-  
itone, and

ht Saving,  
ford Con-  
du es "ai;  
concert Or-

ght Sav-  
mpico, Miss  
Brun wick;  
Club; 7:30,  
adio Poet;  
to Est";  
ray; 9:00,

370).

H. Greenville, Tex., Male Quartet; 11:00-12:00, Recital, Gibson Mandolin and Guitar Club. WFI, Philadelphia, Pa. (Eastern, Daylight Saving, 395), 1:00 p. m., Meyer Davis Bellevue Stratford Concert Orchestra; 3:00, WFI Quartette; 6:00, Sunny Jim, the Kiddies' Pal, songs by Georgie O'Hara; 6:30, Meyer Davis Bellevue Stratford Concert Orchestra; 8:00, Boy Scouts Radio Corps, supversion Boy Scouts of America; 10:10, Charlie Kerr and His Symphonic Dance Orchestra from Majestic Hotel. WGI, Medford Hillside, Mass. (Eastern, Daylight Saving, 360), 12:00 m., Selection on the Ampico in the Chickering; Miss Drew's Ten Minutes; Selections on the Brunswick; 7:00, p. m., Meeting of the Amrad Big Brother Club; 7:30, Talk Geoffrey L. Whalen, "The Radio Movie Man"; Musicale; Popular song hits, "Bernie and his Bunch." WGN, Chicago, Ill. (Central, Daylight Saving, 370), 7:00-8:00 p. m., Address; Lucille Walker, pianist; Oriole Orchestra; 9:00-11:00, Program, "Blanche Blood's studio, Anna Lawrence, violinist; William Swetzer, pianist; Olga Pica, violinist; Minnie Lee, pianist; Chris Fehrenbacher, violinist; Bessie Kohlman, pianist; Lillian Houser, violinist; Margaret Nell, pianist; Rose Lawrence, violinist; Oriole Orchestra. WGR, Buffalo, N. Y. (Eastern Daylight Saving, 319), 12:30-1:00 p. m., George Albert Bouchard, organist; 2:30-4:00, The Radio Dealers Musical Program; 6:00-7:30, Chamber Music Recital. WGY, Schenectady, N. Y. (Eastern, 380), 1:00 p. m.,

inner; 4:20, "Items of interest to women; 4:30, Illinois Federation of Women's Clubs; "Public Welfare," Mrs. H. W. Hartough; 7:00, Boy Scouts weekly talk; Talk, Rockwell R. Stephens; Talk, Ray Mung; 8:40, LaSalle Orchestra; 9:00, "Othin and Thor," Dr. Chester N. Gould; 9:15, Program, Mrs. Crum. WDAW, Omaha, (Central, 526), 6:30 p. m., Dinner dance program; 9:00, Community program by talent from Glenwood, Iowa. WDC, Davenport, Iowa (Central, 484), 12:00 m., Chimes; 3:30 p. m., "Dilation of the Stomach," Karl G. Stephan; 5:45, Chimes; 6:30, Sandman's visit; 9:00, Palmer School Radio Orchestra, Erwin Swindell, director; V. B. Roebte, baritone. WOO, Philadelphia, Pa. (Eastern Daylight Saving, 509), 11:00 a. m., Organ recital, Mary E. Vogt; 12:02 p. m., Wanamaker Crystal Tea Room Orchestra; Robert E. Golden, director; 4:45, Organ recital, Mary E. Vogt. WOQ, Kansas City, Mo. (Central, 360), 3:00-3:30, p. m., Music, Edison Recreation; 7:00-7:30, Varied Musical program under direction of Sam Adair. WDR, Newark, N. J. (Eastern Daylight Saving, 405), 2:45-3:00, Talk on the Centre Market, Newark, N. J., by John Francis Cahill of Newark; 3:30-3:45, Helen Rennyson Wilson, 6:15-6:30, Albert E. Sonn in Radio for the Layman; 6:30-7:30, Musio while you dine, Tom Cooper's Country Club Orchestra. WRC, Washington, D. C. (Eastern, 469), 6:00 p. m., Children's hour, Peggy Albion; 7:45, "The Question Box," The Pathfinder Publication Company; 8:00,

Players. WBAV, Columbus, Ohio (Eastern, 390), 12:00 m., Piano music, Ila Lorbach Owens; 8:00 p. m., Concert, Otterbein College talent; Talk, President W. G. Clippinger; Men's Glee Club; A. R. Spessard, baritone; C. J. Broadhead and Glenn Grant Grabill, pianists; Prof. C. A. Fritz, reader; Otterbein Banjo Orchestra. WBZ, Springfield, Mass. (Eastern, Daylight Saving, 337), 6:00 p. m., Dinner concert, WBZ Orchestra; 7:00, "The Pouch", Youth's Companion; 7:30, Bed-time story for the Kiddies; 10:00, Program, Aaron Richmond, director; 11:00, Chamber music, WBZ Orchestra; Mrs. Gerkin, contralto; Louis Bedard, violinist; Mrs. Ruby Tilton Kingsley, accompanist. WCAE, Pittsburgh, Pa. (Eastern, Daylight Saving, 462), 4:30 p. m., Special children's program, The Sunbino (Girl and Uncle Kaybee); 6:30, Dinner concert, William Penn Hotel; 7:30, Uncle Kaybee; 8:30, Musical program, First Baptist Sunday School Orchestra of New Kensington. WCX, Detroit, Mich. (Eastern, 517), 4:15 p. m., Musical program; 6:00, Dinner concert; 8:30, Music, Caravan Club, Moslem Temple, Order of Mystic Shrine. WDAF, Kansas City, Mo. (Central, 411), 3:30-4:30 p. m., Musical matinee, Request program, the Leo R. Davis Orchestra; 6:00-7:00 p. m., School of the Air, Piano tuning-in number, Duo-Art; Address, speaker from the Kansas City Children's Bureau; Address, Fred Garner, Second of a series on "Radio"; The Tell-Me-a-Story Lady; Fritz Hanlein's Trianon Ensemble; 8:00-9:15, Program arranged, Mrs. Ella

ing, 455), 1:00 p. m., Henry Van Der Zanden's Hotel Ambassador Trio; 4:00, Eleanor Gunn's Fashion Talk; 7:00, Thornton Burgess, bedtime stories; 8:15, The Crescent Trio; 8:45, Talk and Sons by Capt Clarence Clisn; 9:00, The Crescent Trio, 10:00, Eleator Z. ff, soprano; 10:30, Paul Specht's Orchestra. WKAQ, San Juan, P. R. (Intercolonial, 360), 8:00 p. m., WKAQ Orchestra; Studio program, propaganda about the Island of Enchantment. WLAG, Minneapolis-St. Paul, Minn. (Central, 417), 10:45-11:15 a. m., Household Hints; 11:35-12:00 m., Surprise Hour; 2:00-2:30, "Community Fund Talk"; 2:40-4:00, Daylight concert; 4:00-4:30, Mar ne reading; 5:30-6:00, Weekly meeting Children's Radio Health and Toothbrush Club of America; Dr. F. W. Pepper, president; 6:00-6:30, "Radio", Ray R. Sweet; "Cross Country Athletics", Emll Iverson, Coach of Athletics, University of Minnesota; 7:30-8:15, Farm lectures; "What Makes Our Children Grow", John B. Irving; "Planning the Home Garden", R. S. Mackintosh; "Planning and Planting of Silage Crops", R. J. Christie; 9:15, Business Message; 9:30-10:45, Program, Mankato, Minn., Chamber of Commerce; 10:45-12:00, Dance program, St. Paul Hotel Orchestra under Sam J. Helmau, director. WLW, Cincinnati, Ohio (Eastern, Daylight Saving, 309), 4:00 p. m., Lecture, "Journalism", T. C. O'Donnell, editor Writers' Digest. WMAQ, Chicago, Ill. (Central, Daylight Saving, 447 5), 2:35 p. m., Concert, Lyon & Healy recital hall; 4 Dressmaking lessons, Mme. Elizabeth Bel; 4 Pupils, Bush Conservatory; 7:00, Weekly "W (Continued on page 18)



Friday, May 2

(Continued from page 17)

Arako Club, Mrs. Frances M. Ford; 7:30, Musio Memory Contest, Mrs. Marx E. Oberdorfer; 8:00, Americanization lessons; 8:30, LaSalle Orchestra; 9:00, "Modes of Travel in China and Tibet"; Dr. Berthold Lauter; 9:15, Musical program, Cosmopolitan School of Music.
WAW, Omaha, Neb. (Central, 526), 6:30 p. m., Dinner dance music; 9:00, Program, talent from Red Oak, Iowa.
WOC, Davenport, Iowa (Central, 484), 12:00 m., Chimes; 3:30 p. m., "Duetless Glads"; R. G. Maybach; 5:45, Chimes; 6:30, Sandman's visit; 7:00, "Making a Salesman"; J. H. Norridge; 7:30, Sunday School lesson, Dr. Frank Willard Court, pastor; 8:00, Jolly Knights Quartette; Anita Evers, pianist; Concertino solo, Henry P. Hoffman; Ray Stevens, violinist; 9:00, Weekly Tourists' Road Bulletin.
WOO, Philadelphia, Pa. (Eastern, Daylight Saving, 569), 11:00 a. m., Organ recital, Mary E. Vogt; 12:02, 5:09, Wanamaker Crystal Tea Room Orchestra; Robert E. Golden, director; 4:30, Organ recital, Mary E. Vogt; 7:30, Hotel Adelphia Concert Orchestra; 9:30, Organ recital, Mary E. Vogt; 10:02, Havana Casino Dance Orchestra.
WQQ, Kansas City, Mo. (Central, 360), 3:00-3:30 p. m., Wurlitzer Reproducing Piano; 7:00-7:30, International Sunday School lesson, Dr. Walter A. Wilson; 11:00-11:30, Religious Service from studio.
WOR, Newark, N. J. (Eastern, Daylight Saving, 405), 2:30-2:45 p. m., Ida W. Smith, soprano; 3:30-3:45, Ida W. Smith; 6:15-6:30, Agnes Leonard in songs for children; 6:30-7:00, Man in the Moon, stories for children by Josephine Lawrence and Wm. B. McNeary; 7:00-7:30, Recital by William J. Clancy, tenor, assisted by Pierre Connor.
WRC, Washington, D. C. (Eastern, 469), 3:00 p. m., Fashion Developments of the Moment, Women's Wear; 3:10, Songs, Arthur McCormick, baritone; 3:20, "Beauty and Personality"; Elsie Pierce; 3:25, Current topics, editor of The Review of Reviews; 3:25, Ethel Grant, pianist; 4:00, Song recital; 6:00, Stories and songs for children, Peggy Albion and Mary Frances Glenn.
WSB, Atlanta, Ga. (Central, 429), 8:00-9:00 p. m., Girls High School Mandolin Mads; 10:45, Eleanor Craig, Fine Arts Quartette.
WVA, Detroit, Mich. (Eastern, 517), 8:00 a. m., Setting-up exercises, R. J. Horton; 12:00 p. m., Goldkette's Orchestra; 3:00 p. m., Detroit News Orchestra; 7:00, Detroit News Orchestra; Genie La Plante, soprano; Archibald Cooper, haritone.

Saturday, May 3

CKAC, Montreal, Can. (Eastern, 425), 7:00 p. m., Kiddies' stories in French and English; 7:30, Rex Battle and His Mt. Royal Hotel Concert Orchestra; Herbert Spencer, organist; Nap. Dansereau, conductor; 8:00, Concert, Frontenac Breweries, Frontenac Artists and Band, Prize competition announcements; 10:30, Joseph C. Smith and His Mount Royal Hotel Dance Orchestra.
KDKA, E. Pittsburgh, Pa. (Eastern, 326), 5:30 p. m., Dinner concert, Westinghouse Band, T. J. Vastine, director; 6:30, "The Knave of Hearts, He Stole Some Tarts"; 6:45, "Last Minute Helps to Teachers of Adult and Secondary Classes"; Carman O. Johnson; 8:00, Westinghouse Band, T. J. Vastine, conductor.
KFI, Los Angeles, Calif. (Pacific, 469), 6:45-7:30 p. m., Concert of vocal selections; 8:00-9:00, Concert program under arrangement of: Gordon Roth, baritone; 9:00-10:00, Examiner concert; 10:00-11:00, Popular concert; 11:00-12:00, Ambassador-Max Fischer Coconut Grove Orchestra.
KFKX, Hastings, Neb. (Central, 341), Rebroadcasts program of KDKA.
KFNF, Shenandoah, Iowa (Central, 266), 7:30 p. m., Musical program, talent from Villisca, Iowa.
KFDA, Seattle, Wash. (Pacific, 455), 12:00 midnight, Late song hits, Leo Feist Pub. Co.
KGO, Oakland, Calif. (Pacific, 312), 8:00 p. m., Program, Plymouth Congregational Church, Rev. Harry S. McCready, minister; Part I: Lowell Redfield, baritone; Dorothy Buechner, soprano; Rosamond Gilmour, pianist; Merrill Yetter, tenor; Catherine Peterson, alto; Harry S. McCready, reader; Arthur McHoul, pianist; Part II: Song Cycle for Mixed Quartet.
KGW, Portland, Ore. (Pacific, 492), 3:00 p. m., Special musical program; 3:30, Children's program; Story, Aunt Nell; 10:00, Dance music, George Olsen's Metropolitan Orchestra.
KHI, Los Angeles, Calif. (Pacific, 395), 12:30-1:15 p. m., Special program for Music Week arranged by B. Ellis Wales, presenting Gladys Blackwell Pickering, soprano; Raymond Harmon, tenor; 2:30-3:30, Program of vocal and instrumental; 6:00-6:30, Art Hickman's Concert Orchestra; 6:30-7:30, Children's program; Music Memory Contest conducted by Fitzgerald Music Company; "Stories of American History"; Prof. Walter Sylvester Hertzog; Kathryn Sawyer, age 4 years, reader; Cary Boardman, pianist, age 12 years; John T. Brown, harmonica player; Bedtime story, "Uncle John"; 8:00-10:00, Program arranged through courtesy of the Paul G. Hoffman Company; 10:00-11:00, Art Hickman's Dance Orchestra.
KPO, San Francisco, Calif. (Pacific, 423), 1:00-2:00 p. m., Budy Seiger's Fairmont Hotel Orchestra; 2:30-3:30, Mill Bailey Junior Musical Club, Mary Melrose Gardner, director; 3:30-5:30, Tea dansant, E. Max Bradford's Versatile Band; 8:00-12:00, Dance music, Art Weidner and his popular artists; KPO Trio.
KSD, St. Louis, Mo. (Central, 546), 8:00 p. m., Musical program, orchestra, vocalists and specialties.
KYW, Chicago, Ill. (Central, Daylight Saving, 536), 11:25 a. m., Table talk, Mrs. Anna J. Peterson; 6:18-6:28, Talk; 6:45, Children's bedtime story; 7:00-7:35, Dinner concert, Congress Hotel, Joska DeBabary's Orchestra, Paul Whiteman's Celebrated Collegians; 8:00-8:58, Anne Meek, soprano; Isadore T. Mishkin, baritone; J. S. Meek, accompanist; Sallie Menkes, Kathryn Gordon, pianists; Arling Shaeffer, banjoist.
WAAW, Omaha, Neb. (Central, 360), 8:00 p. m., Marches.
WBAH, Minneapolis, Minn. (Central, 417), 12:30-1:30 p. m., Children's Vaudeville, arranged by Minneapolis School of Music; 7:00-7:30, Council of Churches, Rev. O. H. Stettin, St. Olaf Lutheran Church.
WBAP, Fort Worth, Texas (Central, 476), 7:00-7:30 p. m., Sunday School lesson and Radio Bible class, Mrs. W. F. Barum.
WBAV, Columbus, Ohio (Eastern, 390), 12:00 m., Piano music, Ila Lorbach Owens.
WBEZ, Springfield, Mass. (Eastern, Daylight Saving, 337), 6:00 p. m., Dinner concert, Leo Reisman ensemble; 7:00, Leo Reisman and his orchestra; 7:30, 10-minute stories for the kiddies; 7:40, Concert, Hotel Kimball Trio, Jan Geerts, violinist; Angela G. Loneragan, cellist; Paul Lawrence, pianist; 8:30, Music, Home Beautiful exposition; Program arranged by Schroeder studio, Madam Bradley, Mrs. Richardson, Mr. Anno.
WCAE, Pittsburgh, Pa. (Eastern, Daylight Saving, 482), 6:30 p. m., Dinner concert, William Penn Hotel; 7:30, Uncle Kayber; 7:45, Popular songs, Lew Kennedy; Irene Setzler, pianist; 8:30, Al Pascale's Royal Sore adeis.
WCX, Detroit, Mich. (Eastern, 517), 4:15 p. m., Musical program; 6:00, Dinner concert.
WDAF, Kansas City, Mo. (Central, 411), 3:30-4:30 p. m., Musical matinee, the Riley-Elhardt Dance and Concert Orchestra at The Star's Downtown Studio, Roof Garden, Kansas City Athletic Club; 6:00-7:00 p. m., School of the Air; Piano tuning-in number, Duo-Art; Address, Edgar Linton, writer and lecturer of Kansas City; The Tell-Me-a-Story Lady; Fritz Hanlein's Trianon Ensemble, Hotel Muehlebach; 8:00-9:00, Popular program by De Moley Orchestra and comedy songs and dialogue by Billy Hallett and Ralph Fleming; 11:45 p. m., 1:00 a. m., the "Merry Old Chief", and the Coon-Sanders Orchestra.
WDAF, Philadelphia, Pa. (Eastern, Daylight Saving, 395), 11:45 a. m., Daily Almanac; 12:02 p. m., Organ recital, Stanley Theater; 12:30, Arcadia Cafe Concert Orchestra; 2:00, Arcadia Cafe Concert Orchestra; 4:30, Betsy Logan, "Gowns and Gossip"; 7:30, Special features from Stanley Theater; 7:45, Dream Daddy's bedtime stories; 8:00, Opera Talk by Samuel Lacler; 9:30, Overture by Stanley Theater Orchestra, Josef Pasernack, director; 10:05, Howard Lanin's Arcadia Cafe Dance Orchestra.
WEAF, New York, N. Y. (Eastern, Daylight Saving, 492), 4:00 p. m., Blanche E. Outwater, soprano; 4:30, Kenneth Casey's Society Orchestra; 5:00, Women's Program; 7:20, Judge Moses G. Gathman; 8:30, Thornton Fisher; 7:40, Paul Kravath; 7:55, Mel Levine, violinist; 8:15, Lewis Williamson, tenor; 8:30, Hall & McNamara Co. Program; 8:50, Lawyers Mortgage Co.; 9:00, Bella Girard, contralto; 9:30, Gypsy Siring Ensemble.
WEAO, Columbus, Ohio (Eastern, 360), 1:30 p. m., Garden talk.
WFAC, Dallas, Texas (Central, 476), 12:00-1:00 p. m., "Principles and Men"; Dr. J. B. Cranfill; 8:30-9:30, Concert, Gospel-in-Song Quartette, B. M. Taylor, director; 11:00-12:00, Special Program by Mexican talent.
WFI, Philadelphia, Pa. (Eastern, Daylight Saving, 395), 1:00 p. m., Meyer Davis Bellevue Stratford Orchestra; 3:00, Tenor solos, Ednyrd Lewis; 6:00, Sunny Jim, the Kiddies' Pal; 8:30, Merer Davis Bellevue Stratford Concert Orchestra; 7:00, Music lesson for children by Elsie Alexander.
WGR, Buffalo, N. Y. (Eastern, Daylight Saving, 319), 2:30-4:00 p. m., George Albert Bouchard, organist; 2:30-4:00, The Radio Dealers Musical Program; 6:30-7:30 and 11:00, Vincent Lopez Hotel Statter Orchestra; 8:50-9:00, Address, "The Normal School"; Harry W. Rockwell; 9:00-11:00, Concert, The Browning-King Entertainers, direction, J. P. Quinn.
WGY, Schenectady, N. Y. (Eastern, 380), 7:45 p. m., Program, Georgine Servos' Coral Club; Mrs. Charles W. Clark, soprano; "Radicalism That Means Real Progress"; Charlea M. Ripley; Olive Pearson, contralto.
WHAS, Louisville, Ky. (Central, 400), 4:00-5:00 p. m., Selections, Walnut Theater Orchestra; Alamo Theater organ.
WHAZ, New York, N. Y. (Eastern, 380), 9:00 p. m., Concert, Troy Conservatory of Music; 9:45, Educational talk, member of faculty of Berea College, Polytechnic Institute; 10:30, Dance music, Flush's Orchestra.
WHB, Kansas City, Mo. (Central, 411), 12:35-1:00 p. m., Popular music, Sweeney Radio Orchestra; 2:00-3:00 p. m., Ladies' Hour program, Sweeney Radio Orchestra; 7:00-8:00 p. m., Varied musical program, Sweeney Radio Orchestra; "Romance of Marble," C. P. VonNostrand.
WIP, Philadelphia, Pa. (Eastern, Daylight Saving, 509), 1:00 p. m., Gimmel Brothers' Tea Room Orchestra; 4:00 p. m., Lesson in Mah Jong by Mr. and Mrs. Wei Lum Woon; 6:00-6:15, "The Normal School"; Baseball dope by Monto Cross; 6:05, Walter Schurz Orchestra from Venetian Cafe; 7:00, Uncle Wip's bedtime stories.
WLAG, Minneapolis-St. Paul, Minn. (Central, 417), 10:45-11:15 a. m., Household Hints; 11:35-12:00, Surprise hour, Meeting Postcard Club, Earle R. Buell, president; 7:30-8:15, Business Message; 9:15-10:15, Musical program, Businessmen's Association of Little Falls, Minn.; 11:00-12:30, Dnsce prgrsm, St. Paul Hotel Orchestra.
WMAQ, Chicago, Ill. (Central, Daylight Saving, 447.5), 7:30 p. m., Band concert, Wells Park Community Band; 9:00, Balaban and Katz, Chicago Theater rerun.
WDAW, Omaha, Neb. (Central, 526), 6:30 p. m., Dinner dance music; 9:00, Musiale, auspices of Omaha Printing Company.
WOC, Davenport, Iowa (Central, 484), 12:00 m., Chimes; 3:30 p. m., "The Sugar Chemist"; C. C. Hall; 5:45, Chimes; 6:30, Sandman's visit; 9:00, Palmer School Radio Orchestra; V. B. Rochte, baritone.
WOO, Philadelphia, Pa. (Eastern, Daylight Saving, 509), 11:00 a. m., Organ recital, Mary E. Vogt; 12:02 p. m., Wanamaker Crystal Tea Room Orchestra, Robert E. Golden, director; 4:45, Organ recital, Mary E. Vogt.
WOR, Newark, N. J. (Eastern, Daylight Saving, 405), 2:30-4:00 p. m., Boys' Program; 6:15-7:15, "Music While You Dine"; Paul Van Loan's Cincinnati Orchestra; 7:15-7:30, Fred J. Bendel, on Sporting News 'Up to the Minute'; 8:00-9:00, Gene Ingraham's Bell Record Orchestra; 9:00-9:15, Donald Short of the N. Y. American in a talk; 10:15-11:00, Program by the Ben Friedman Entertainers.
WRC, Washington, D. C. (Eastern, 469), 6:00 p. m., Children's hour, Peggy Albion; 7:45, Bible talk, auspices Men's Organized Bible Class of D. C.; 8:00, Alfred Fallon, violinist; 8:15, Song recital, Dorothy Mansfield; 8:30, Song recital, Edouard Albion, baritone; 8:45, Piano; 9:00, Edouard Albion, baritone; 9:15, Instrumental music; 10:00, Hawaiian music.
WSB, Atlanta, Ga. (Central, 429), 8:00-9:00 p. m., Non-political jamboree, Atlanta City Hall Democrats; 10:45, Classic concert, Mary Dangsing choristers.
WTAM, Cleveland, Ohio (Eastern, 390), 9:00 p. m., Dance program WTAM Dance Orchestra; Choral numbers, Girls' Glee Club of Hiram College, Hiram, Ohio; Solos Camille Killian, Corinne Woodruff, Anita Bancroft, Lou Emily Bower, Margaret Pearce, piano.
WWJ, Detroit, Mich. (Eastern, 517), 8:00 a. m., Setting-up exercises; 12:00 p. m., Edward Barnes, baritone; LeRoy DeTurk, tenor; 3:00 p. m., Detroit News Orchestra; 7:00, Detroit News Orchestra.

Where to Hear Dramas

DRAMAS, humorous, serious, musical comedies and even operettas are broadcast during the week and below are the stations and dates.
Tuesday: WGY, "The Pirates of Penzance," WGY Light Opera Co.; WLAG, Playlet, WLAG Players.
Wednesday: KDKA, One-act Play, Dramatic League of Pittsburgh; WMAQ, Play, Chicago Rotary Club.
Thursday: KGO, "Daddy Long Legs," KGO Players; WGY, "The Walls of Jericho," WGY Players.
Friday: WDAW, Radio Playlet, Walter Greenough's WDAW Players; WGN, "HMS Pinafore," WGN Light Opera Co.

Sunday, May 4

CKAC, Montreal, Can. (Eastern, 425), 4:30 p. m., Special concert.
KFI, Los Angeles, Calif. (Pacific, 469), 10:00-10:45 a. m., Sacred Service conducted by L. A. Church Federation; 4:00-5:00 p. m., Vesper Service, Federation Church; Musicians; 6:45-7:30, Concert program; 8:00-9:00, Ambassador Hotel concert; 9:00-10:00, Examiner concert; 10:00-11:00, Orchestra concert.
KFNF, Shenandoah, Iowa (Central, 266), 3:00 p. m., Religious services, Presbyterian Church of Shenandoah; 6:30, Sacred service; Sermonette.
KFSG, Los Angeles, Calif. (Pacific, 278), 10:30 a. m.-12:30 p. m., Entire sacred church service conducted by Aime Semple McPherson; 2:30-4:30 p. m., Complete message of worship and afternoon service by Aime Semple McPherson; 6:30-7:00, Children's hour under direction of Mrs. M. Kennedy; 7:00-7:30, Special concert of sacred vocal and instrumental numbers; 8:00-10:00, Regular revival service conducted by Aime Semple McPherson; 10:02-10:10, The Family Altar and prayer led by Aime Semple McPherson; The Angelus Temple Chimes will ring of KFSG.
KGO, Portland, Ore. (Pacific, 492), 6:00 p. m., Church services, Portland Council of Churches; 7:00, George Olsen's concert orchestra.
KHI, Los Angeles, Calif. (Pacific, 395), 10:00 a. m., Sermon in Studio of KHI; 10:30 a. m.-12:30 p. m., Organ recital and entire service from First Methodist Episcopal Church; Arthur Blakeley, organist; Rev. Elmer E. Helma, pastor; 7:00-7:30 p. m., Organ recital from First M. E. Church, Arthur Blakeley, organist; 8:00-10:00, De Luxe program.
KYW, Chicago, Ill. (Central, Daylight Saving, 536), 11:00 a. m., Central Church service, Dr. F. P. Shannon, pastor; 2:30 p. m., Studio Chapel service, direction of Chicago Church Federation; 7:00, Preliminary Service, Chicago Sunday Evening Club; 7:40, Organ recital, Stanley Martin; 8:00, Regular meeting of the Chicago Sunday Evening Club, Orchestra Hall, speaker, Dr. W. L. Speery.
WAAW, Omaha, Neb. (Central, 360), 7:30 p. m., Church services, First Congregation Church, Oakland, Iowa, Rev. R. W. Roberts, pastor.
WBAP, Fort Worth, Texas (Central, 476), 11:00 a. m.-12:15 p. m., Church services, First Methodist Church, Rev. J. W. Bergin, pastor; 4:00-5:00, Organ recital, Miss Margaret Agnew White; 5:00-6:00, Concert, Mrs. Will S. Horn, violinist, J. F. Garnon, violinist, and Joeel Garrison, pianist; 11:00-12:00, Midnight concert.
WCX, Detroit, Mich. (Eastern, 517), 10:30 a. m., Services Central M. E. Church, Dr. Lynn Harold Hough, pastor; Hudson quartets; 2:30 p. m., Harold chapel services, Gilesons.
WDAF, Kansas City, Mo. (Central, 411), 4:00-5:00 p. m., Vesper service, St. Marks Lutheran Church Choir, directed by Charles Aiken.
WDAF, Chicago, Ill. (Central, Daylight Saving, 360), 5:00-6:00 p. m., Barton organ recital played by Ralph Emerson; 9:15, Isador T. Mishkin, tenor; Drake concert ensemble.
WDAF, Philadelphia, Pa. (Eastern, Daylight Saving, 395), 2:00 p. m., Concert, Arcadia Cafe Concert Orchestra, direction Ferl Sarkozl; 8:30, Organ recital, Stanley Theater.
WEAF, New York, N. Y. (Eastern, Daylight Saving, 492), 10:00-12:00 p. m., Annual Communion Breakfast, Holy Name; 2:45 p. m., New York Federation of Churches; 3:45, Dr. S. Parkes Cadman; 7:20, Capitol Theatre Orchestra and Rox's "Gang"; 9:00, Skinner Organ Recital.
WFAC, Dallas, Texas (Central, 476), 6:00-7:00 p. m., Radio Bible Class, Dr. William M. Anderson; 9:00-9:30, Address, Dr. Harry Lee Virden; 9:30-11:00, Popular music recital, Jack A. Davis and his Orchestra.
WFI, Philadelphia, Pa. (Eastern, Daylight Saving, 395), 7:30 p. m., Services from Arch Street Presbyterian Church.
WGI, Medford Hillside, Mass. (Eastern, Daylight Saving, 360), 4:00 p. m., "Adventure Hour," Youth's Companion; Address, Rev. F. A. Wiggin; Albert E. Adams, pianist; 8:30, Talk, auspices Greater Boston Federation of Churches; Musicales.
WGN, Chicago, Ill. (Central, Daylight Saving, 370), 6:00-9:20 p. m., Dorothy McFarland, soprano; Blake Wilson, baritone; J. Henry Welton, tenor; Edna Crum, violinist; Oriole Orchestra.
WGR, Buffalo, N. Y. (Eastern, Daylight Saving, 319), 7:30 p. m., Vesper service, Rev. Peter J. Brunner of the High Street Baptist Church, speaker; 4:00, Organ Recital, Robert Munn.
WGY, Schenectady, N. Y. (Eastern, 380), 10:00 a. m., Services, Union Presbyterian Church, Rev. T. Roseberry Good; 2:30 p. m., WGY Orchestra; Leonard W. Grant, baritone; 6:30, Services, Union Presbyterian Church.
WHAA, Iowa City, Iowa (Central, 484), 4:00 p. m., Vesper service, Address, Rev. Benjamin F. Wyland, pastor, Union Congregational Church; 9:00, Familiar Chimes, Louisa G. Crawford.
WHAS, Louisville, Ky. (Central, 400), 9:57 a. m., Organ music; 10:00, Church services, Fourth Avenue Presbyterian Church, Rev. Dr. Charles V. Welch, pastor; William E. Cone, organist; 4:00-5:00, Bethel College Glee Club, Check Evans, director.
WHB, Kansas City, Mo. (Central, 411), 12:35-1:00 p. m., Popular program, Sweeney Radio Orchestra; 2:00-3:00 p. m., Ladies' Hour program, Sweeney Radio Orchestra; 7:00-8:00 p. m., Varied musical program, Sweeney Radio Orchestra; "Romance of Marble," C. P. VonNostrand.
WIP, Philadelphia, Pa. (Eastern, Daylight Saving, 509), 1:00 p. m., Gimmel Brothers' Tea Room Orchestra; 4:00 p. m., Lesson in Mah Jong by Mr. and Mrs. Wei Lum Woon; 6:00-6:15, "The Normal School"; Baseball dope by Monto Cross; 6:05, Walter Schurz Orchestra from Venetian Cafe; 7:00, Uncle Wip's bedtime stories.
WLAG, Minneapolis-St. Paul, Minn. (Central, 417), 10:45-11:15 a. m., Household Hints; 11:35-12:00, Surprise hour, Meeting Postcard Club, Earle R. Buell, president; 7:30-8:15, Business Message; 9:15-10:15, Musical program, Businessmen's Association of Little Falls, Minn.; 11:00-12:30, Dnsce prgrsm, St. Paul Hotel Orchestra.
WMAQ, Chicago, Ill. (Central, Daylight Saving, 447.5), 7:30 p. m., Band concert, Wells Park Community Band; 9:00, Balaban and Katz, Chicago Theater rerun.
WDAW, Omaha, Neb. (Central, 526), 6:30 p. m., Dinner dance music; 9:00, Musiale, auspices of Omaha Printing Company.
WOC, Davenport, Iowa (Central, 484), 12:00 m., Chimes; 3:30 p. m., "The Sugar Chemist"; C. C. Hall; 5:45, Chimes; 6:30, Sandman's visit; 9:00, Palmer School Radio Orchestra; V. B. Rochte, baritone.
WOO, Philadelphia, Pa. (Eastern, Daylight Saving, 509), 11:00 a. m., Organ recital, Mary E. Vogt; 12:02 p. m., Wanamaker Crystal Tea Room Orchestra, Robert E. Golden, director; 4:45, Organ recital, Mary E. Vogt.
WOR, Newark, N. J. (Eastern, Daylight Saving, 405), 2:30-4:00 p. m., Boys' Program; 6:15-7:15, "Music While You Dine"; Paul Van Loan's Cincinnati Orchestra; 7:15-7:30, Fred J. Bendel, on Sporting News 'Up to the Minute'; 8:00-9:00, Gene Ingraham's Bell Record Orchestra; 9:00-9:15, Donald Short of the N. Y. American in a talk; 10:15-11:00, Program by the Ben Friedman Entertainers.
WRC, Washington, D. C. (Eastern, 469), 6:00 p. m., Children's hour, Peggy Albion; 7:45, Bible talk, auspices Men's Organized Bible Class of D. C.; 8:00, Alfred Fallon, violinist; 8:15, Song recital, Dorothy Mansfield; 8:30, Song recital, Edouard Albion, baritone; 8:45, Piano; 9:00, Edouard Albion, baritone; 9:15, Instrumental music; 10:00, Hawaiian music.
WSB, Atlanta, Ga. (Central, 429), 8:00-9:00 p. m., Non-political jamboree, Atlanta City Hall Democrats; 10:45, Classic concert, Mary Dangsing choristers.
WTAM, Cleveland, Ohio (Eastern, 390), 9:00 p. m., Dance program WTAM Dance Orchestra; Choral numbers, Girls' Glee Club of Hiram College, Hiram, Ohio; Solos Camille Killian, Corinne Woodruff, Anita Bancroft, Lou Emily Bower, Margaret Pearce, piano.
WWJ, Detroit, Mich. (Eastern, 517), 8:00 a. m., Setting-up exercises; 12:00 p. m., Edward Barnes, baritone; LeRoy DeTurk, tenor; 3:00 p. m., Detroit News Orchestra; 7:00, Detroit News Orchestra.

Monday, May 5

CKAC, Montreal, Can. (Eastern, 425), 1:45 p. m., Mt. Royal Hotel Classic concert; 4:30, Mt. Royal Hotel Dance Orchestra.

CKY, Winnipeg, Can. (Central, 450), 1:00 p. m., Lecture, Professor from Agricultural College; 5:00, Lectures on "French," U. of Manitoba.
KFAE, Pullman, Wash. (Pacific, 330), 7:30 p. m., "Can the Modern Church Prevent War?" Rev. Clay Palmer; Marguerite Miller, soprano; Mining talk, Dean L. O. Howard, Louis Wersen, saxophonist; Plant pathology, George Severance; Irmingarde King, pianist; Guitar trio, Rex Turner, Reginald Cooper, Horace Cornille; "Cod Liver Oil for Chickens," W. D. Buchanan.
KFI, Los Angeles, Calif. (Pacific, 469), 8:00-9:00 p. m., Evening Herald concert; 9:00-10:00, Examiner concert; 10:00-11:00, Ambassador-Max Fischer Coconut Grove Orchestra.
KFKX, Hastings, Neb. (Central, 341), 9:30 p. m., Program, Hastings Tribune.
KFOA, Seattle, Wash. (Pacific, 455), 8:30 p. m., Bab's B. E. Ladies orchestra, Margaret Dicken, leader.
KGO, Portland, Ore. (Pacific, 492), 3:30 p. m., Literary program, Portland Library Association; 7:00, Talk, representative, Parent-Teachers Association; 8:00, Recital, Halfred Young, tenor.
KHJ, Los Angeles, Calif. (Pacific, 395), 12:30-1:15 p. m., Concert.
WAAM, Newark, N. J. (Eastern, Daylight Saving, 255), 7:00-7:30 p. m., "Star Spangled Banner," James V. Moore and his Seven Bearcats; 7:30-7:45, Victor Wilbur, baritone, Jos. Macy, piano; 7:45-8:00, "Why Children Become Criminals," talk by Jack Cunard, ex-criminal; 8:00-9:00, Nelson Rogers' WAAAM Dance Orchestra; 9:00-9:15, Harry Wallace Lund, Broadway radio critic; 9:15-9:30, Times Square Entertainers; 9:30-9:45, E. L. Shoemaker, radio doctor; 9:45-10:00, Times Square Entertainers; 10:00-10:15, Bernard Macfadon, father of "Physical Culture"; 10:15-10:30, Thomas Hamilton, tenor; 10:30-10:45, Frank Messenger, tenor, and Wm. Adtman, pianist; 10:45-11:15, Hume Gibson, saxophonist and Ethel Johnson Gibson, pianist.
WAAW, Omaha, Neb. (Central, 360), 7:30 p. m., Rainbow Snappers, Herbert Voerster, director.
WBAH, Minneapolis, Minn. (Central, 417), 12:30-1:30 p. m., Dick Long's Trio and soloist; 9:30-11:00, Donald Penhough, tenor; Alice Schmauss, violinist; Helen Hermsfle, contralto; Mrs. A. J. Babcock, pianist and accompanist.
WBAP, Fort Worth, Texas (Central, 476), 7:30-8:30 p. m., Concert, G. W. Mallory's Quartette of Roswell, Texas; 9:30-10:45, Concert, Moslah Temple Shrine Band.
WBAV, Columbus, Ohio (Eastern, 390), 12:00 m., Piano music, Ila Lorbach Owens; 8:00 p. m., WBAV Orchestra, Frances Handibeau, director.
WBCD, Zion, Ill. (Central, 345), 8:00 p. m., Mixed Quartette; G. R. Sparrow, tenor; J. L. Bishop, baritone; Stewart, cornetist; Mrs. H. E. Mayfield, soprano; E. B. Paxton, baritone; William C. Dunn, euphonium soloist.
WCX, Detroit, Mich. (Eastern, 517), 4:15 p. m., Musical program; 6:00, Dinner concert; 7:00, Music.
WDAF, Kansas City, Mo. (Central, 411), 3:30-4:30 p. m., Musical matinee, Milo Finley's Orchestra at The Star's downtown studio; 6:00-7:00, School of the Air; Piano tuning-in number, Duo-Art; Report; Address, speaker from the University of Kansas; The Tell-Me-a-Story Lady; Music, Fritz Hanlein's Trianon Ensemble, Hotel Muehlebach; 8:00-9:00, Popular program by De Moley Orchestra and comedy songs and dialogue by Billy Hallett and Ralph Fleming; 11:45 p. m., 1:00 a. m., the "Merry Old Chief", and the Coon-Sanders Orchestra.
WDAF, Philadelphia, Pa. (Eastern, Daylight Saving, 395), 11:45 a. m., Daily Almanac; 12:02 p. m., Organ recital, Stanley Theater; 12:30, Arcadia Cafe Concert Orchestra; 2:00, Arcadia Cafe Concert Orchestra; 4:30, Betsy Logan, "Gowns and Gossip"; 7:30, Special features from Stanley Theater; 7:45, Dream Daddy's bedtime stories; 8:00, Opera Talk by Samuel Lacler; 9:30, Overture by Stanley Theater Orchestra, Josef Pasernack, director; 10:05, Howard Lanin's Arcadia Cafe Dance Orchestra.
WEAF, New York, N. Y. (Eastern, Daylight Saving, 492), 4:00 p. m., Blanche E. Outwater, soprano; 4:30, Kenneth Casey's Society Orchestra; 5:00, Women's Program; 7:20, Judge Moses G. Gathman; 8:30, Thornton Fisher; 7:40, Paul Kravath; 7:55, Mel Levine, violinist; 8:15, Lewis Williamson, tenor; 8:30, Hall & McNamara Co. Program; 8:50, Lawyers Mortgage Co.; 9:00, Bella Girard, contralto; 9:30, Gypsy Siring Ensemble.
WEAO, Columbus, Ohio (Eastern, 360), 1:30 p. m., Garden talk.
WFAC, Dallas, Texas (Central, 476), 12:00-1:00 p. m., "Principles and Men"; Dr. J. B. Cranfill; 8:30-9:30, Concert, Gospel-in-Song Quartette, B. M. Taylor, director; 11:00-12:00, Special Program by Mexican talent.
WFI, Philadelphia, Pa. (Eastern, Daylight Saving, 395), 1:00 p. m., Meyer Davis Bellevue Stratford Orchestra; 3:00, Tenor solos, Ednyrd Lewis; 6:00, Sunny Jim, the Kiddies' Pal; 8:30, Merer Davis Bellevue Stratford Concert Orchestra; 7:00, Music lesson for children by Elsie Alexander.
WGR, Buffalo, N. Y. (Eastern, Daylight Saving, 319), 2:30-4:00 p. m., George Albert Bouchard, organist; 2:30-4:00, The Radio Dealers Musical Program; 6:30-7:30 and 11:00, Vincent Lopez Hotel Statter Orchestra; 8:50-9:00, Address, "The Normal School"; Harry W. Rockwell; 9:00-11:00, Concert, The Browning-King Entertainers, direction, J. P. Quinn.
WGY, Schenectady, N. Y. (Eastern, 380), 7:45 p. m., Program, Georgine Servos' Coral Club; Mrs. Charles W. Clark, soprano; "Radicalism That Means Real Progress"; Charlea M. Ripley; Olive Pearson, contralto.
WHAS, Louisville, Ky. (Central, 400), 4:00-5:00 p. m., Selections, Walnut Theater Orchestra; Alamo Theater organ.
WHAZ, New York, N. Y. (Eastern, 380), 9:00 p. m., Concert, Troy Conservatory of Music; 9:45, Educational talk, member of faculty of Berea College, Polytechnic Institute; 10:30, Dance music, Flush's Orchestra.
WHB, Kansas City, Mo. (Central, 411), 12:35-1:00 p. m., Popular music, Sweeney Radio Orchestra; 2:00-3:00 p. m., Ladies' Hour program, Sweeney Radio Orchestra; 7:00-8:00 p. m., Varied musical program, Sweeney Radio Orchestra; "Romance of Marble," C. P. VonNostrand.
WIP, Philadelphia, Pa. (Eastern, Daylight Saving, 509), 1:00 p. m., Gimmel Brothers' Tea Room Orchestra; 4:00 p. m., Lesson in Mah Jong by Mr. and Mrs. Wei Lum Woon; 6:00-6:15, "The Normal School"; Baseball dope by Monto Cross; 6:05, Walter Schurz Orchestra from Venetian Cafe; 7:00, Uncle Wip's bedtime stories.
WLAG, Minneapolis-St. Paul, Minn. (Central, 417), 10:45-11:15 a. m., Household Hints; 11:35-12:00, Surprise hour, Meeting Postcard Club, Earle R. Buell, president; 7:30-8:15, Business Message; 9:15-10:15, Musical program, Businessmen's Association of Little Falls, Minn.; 11:00-12:30, Dnsce prgrsm, St. Paul Hotel Orchestra.
WMAQ, Chicago, Ill. (Central, Daylight Saving, 447.5), 7:30 p. m., Band concert, Wells Park Community Band; 9:00, Balaban and Katz, Chicago Theater rerun.
WDAW, Omaha, Neb. (Central, 526), 6:30 p. m., Dinner dance music; 9:00, Musiale, auspices of Omaha Printing Company.
WOC, Davenport, Iowa (Central, 484), 12:00 m., Chimes; 3:30 p. m., "The Sugar Chemist"; C. C. Hall; 5:45, Chimes; 6:30, Sandman's visit; 9:00, Palmer School Radio Orchestra; V. B. Rochte, baritone.
WOO, Philadelphia, Pa. (Eastern, Daylight Saving, 509), 11:00 a. m., Organ recital, Mary E. Vogt; 12:02 p. m., Wanamaker Crystal Tea Room Orchestra, Robert E. Golden, director; 4:45, Organ recital, Mary E. Vogt.
WOR, Newark, N. J. (Eastern, Daylight Saving, 405), 2:30-4:00 p. m., Boys' Program; 6:15-7:15, "Music While You Dine"; Paul Van Loan's Cincinnati Orchestra; 7:15-7:30, Fred J. Bendel, on Sporting News 'Up to the Minute'; 8:00-9:00, Gene Ingraham's Bell Record Orchestra; 9:00-9:15, Donald Short of the N. Y. American in a talk; 10:15-11:00, Program by the Ben Friedman Entertainers.
WRC, Washington, D. C. (Eastern, 469), 6:00 p. m., Children's hour, Peggy Albion; 7:45, Bible talk, auspices Men's Organized Bible Class of D. C.; 8:00, Alfred Fallon, violinist; 8:15, Song recital, Dorothy Mansfield; 8:30, Song recital, Edouard Albion, baritone; 8:45, Piano; 9:00, Edouard Albion, baritone; 9:15, Instrumental music; 10:00, Hawaiian music.
WSB, Atlanta, Ga. (Central, 429), 8:00-9:00 p. m., Non-political jamboree, Atlanta City Hall Democrats; 10:45, Classic concert, Mary Dangsing choristers.
WTAM, Cleveland, Ohio (Eastern, 390), 9:00 p. m., Dance program WTAM Dance Orchestra; Choral numbers, Girls' Glee Club of Hiram College, Hiram, Ohio; Solos Camille Killian, Corinne Woodruff, Anita Bancroft, Lou Emily Bower, Margaret Pearce, piano.
WWJ, Detroit, Mich. (Eastern, 517), 8:00 a. m., Setting-up exercises; 12:00 p. m., Edward Barnes, baritone; LeRoy DeTurk, tenor; 3:00 p. m., Detroit News Orchestra; 7:00, Detroit News Orchestra.

(Continued on page 28)



# 30 Minute A-B-C Lessons for Radio Beginners

## Chapter VII—Essentials of Radio Electricity

By P. E. Edelman

IN this series of articles the story of Radio is told in so simple a manner that the uninitiated can follow theory and practice whether he knows anything about electricity or its application to broadcasting and reception or not. The series consists of twenty-five chapters, of which the five next will be:

Chapter VIII—The Key to Radio Circuits.  
Chapter IX—Radio's Cast of Characters.  
Chapter X—What a Vacuum Tube Does.  
Chapter XI—The Shorthand of Radio—Diagram Reading.  
Chapter XII—Catching Radio Waves.

THE mystery inside of a Radio set soon begins to clear when a few of the elementary principles of electricity are recognized.

Batteries are used to supply local electrical energy to operate receiving sets. A battery called an A battery is used to light the filament of a vacuum tube, and a battery called a B battery is used to supply the local plate energy for the vacuum tube.

The principle of a battery is diagrammed in Figure 71. When a piece of zinc metal and a piece of carbon are inserted into a solution of the chemical, sal ammoniac, certain distributions occur in the electrons in the zinc. At the surface of the zinc, at the contact of the zinc with the sal ammoniac and water, at the contact of the solution and the carbon

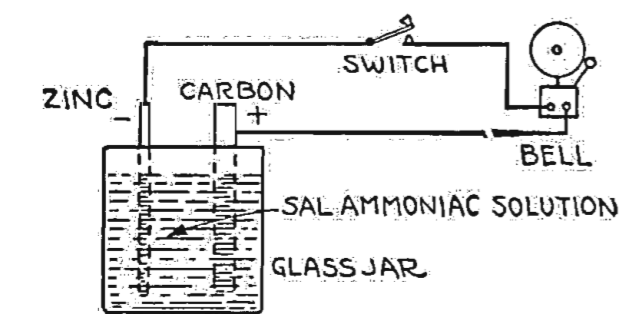

BATTERY

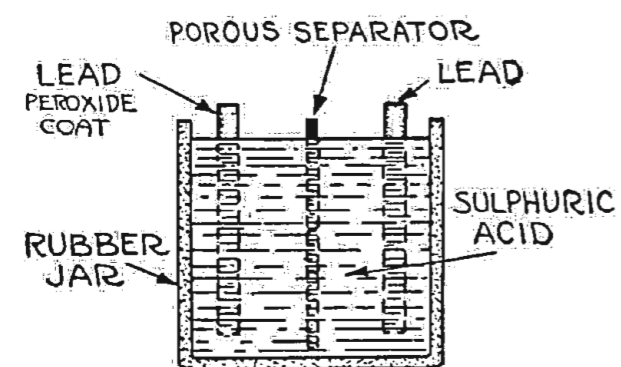

Figure 71.

and at the surface of the carbon, a quantity of electrons flow from the carbon plate through an external wire to the zinc plate. A chemical change also occurs during the action and some of the zinc metal goes into solution combining with the chemical electrolyte. Essentially, a battery changes chemical energy into electrical form and the zinc in this case is in a sense burned much the same as is coal in a furnace.

The labels "plus" and "minus" are such as have been arbitrarily established to indicate current flow, as going from the positive plate, carbon, through the wire, to the negative plate, zinc. A dry bat-

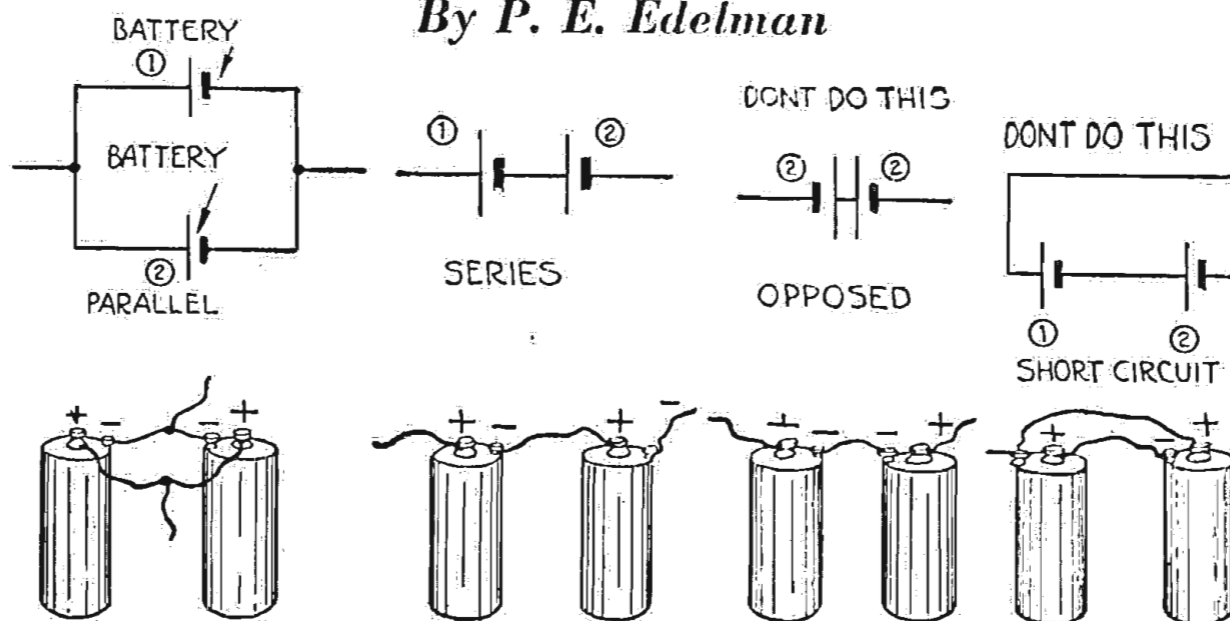

Figure 72.

tery is operated on much the same principle and is really not dry but moist, with the electrolyte in the form of a gelatinous-like mass. The usual forms of dry cells have the zinc plate outside acting as a container, and also comprise certain auxiliary chemical agents or depolarizers to assist the desired action.

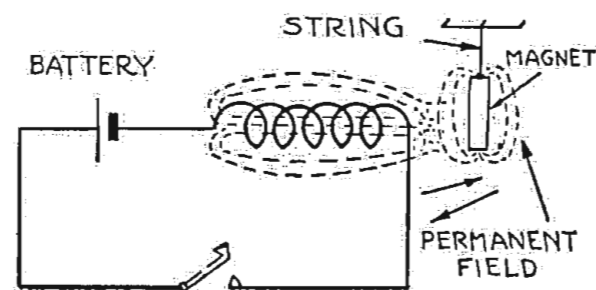

Figure 73.

The A battery is called upon to supply a current to heat the wire filament of a vacuum tube, and will run down or become exhausted after a time. The B battery supplies a higher voltage or pressure and is made up of a number of cells in series. These cells are of smaller dimensions because the current required is very small.

### Storage Battery

A storage battery, also diagrammed in Figure 71, is used where a steady current is required, and is called so because when run down, the original chemical condition in the battery can be restored by sending electric current through it. In the lead acid type of storage battery two lead plates are separated in a jar of dilute

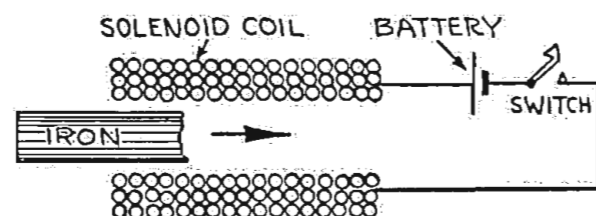

Figure 74.

sulphuric acid. One lead plate, the positive, is given a surface coating of lead peroxide, a brown appearing chemical. Then when an external wire connects the two plates, a current flows from the peroxide coated plate through the wire to the lead plate.

After a time of use, both plates will get down to the same potential so that

the electron distribution in the battery is equalized and there can be no external current flow. Then the battery can be recharged, that is to say, a new peroxide coat can be applied to one lead plate by passing electricity from an outside source through the battery, thus changing the concentration of the electrolyte and the chemical equilibrium in the cell. A storage battery really stores chemical energy rather than electricity. When fresh a dry cell usually affords slightly better than 1.5 volts at the terminals but cannot supply a heavy steady current without rapidly running down.

When freshly charged a storage cell affords closely 2.2 volts and can give a heavy steady current for considerable time. Batteries also have resistance, called internal resistance. In the case of B batteries made up of a number of cells, this internal resistance has a noticeable effect and sometimes condensers are employed to bypass the battery to Radio cur-

rents. In using batteries of the dry cell type, remember that they will run down and must be renewed. As for the cell, they should be used with care and replenished with distilled water from time to time as advised by the manufacturer. Do not use for B batteries run-down cells for they will not give the current they furnish a battery of 1.5-volt

### Series and Parallel Connections

Figure 72 shows the two common ways for batteries, series and parallel. If two equal cells, 1 and 2 are connected in parallel, that is to say with the positive plate to the positive plate and negative to negative, this gives a battery of twice the effective current capacity but the same voltage as one cell. In a series connection, one positive plate to one negative plate of the other battery, this com-

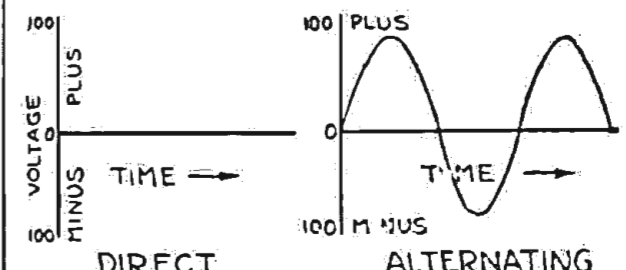

Figure 75.

combination affords a battery of double the terminal voltage of one cell, and the same capacity. In a series connection if one cell goes bad, as often happens in a B battery which comprises several cells in series sealed up into one unit, the entire combination can pass no more current than can go through this one bad cell, for it then acts as a high internal resistance.

### Fluctuating Current from Dry Cells

Dry cells used for B batteries will sometimes become polarized or depleted

(Continued on page 24)



# WD-11

Radiotron WD-11 is famous as the tube that really made possible the swift growth of radio in the home, as we know it today.

Inexpensive to operate—using but one 1½-volt dry cell—doing away with the need for storage batteries—it has lowered the cost of radio.

Price \$5.00

Radio Corporation of America

Sales Offices—Dept. 315  
233 Broadway, New York

10 South LaSalle St.,  
Chicago, Ill.

433 California St.,  
San Francisco, Cal.

Be sure that every vacuum tube you buy is marked **RADIOTRON**



# Radiotrons

REG. U. S. PAT. OFF.

Parcel Post prepaid on all orders above \$5.00.

Express Money Order, Certified Check, Bank Draft accepted; also C. O. D.

Guarantee with all merchandise.

PEARLESS

RADIO

349  
Fulton St.  
BROOKLYN  
N. Y.

---

JUST OFF THE PRESS

OUR NEW CATALOGUE AND PRICE LIST. SEND 4c IN STAMPS TO COVER POSTAGE FOR SAME

<p>Complete Parts for <b>Neutrodyne 5 Tube Set</b></p> <ul style="list-style-type: none"> <li>1 7x26 Panel</li> <li>2 Single Sockets</li> <li>1 Triple Socket</li> <li>2 Neutrodons</li> <li>1 Neutroformer</li> <li>2 All American Transformers</li> <li>1 Battery Switch</li> <li>3 4" Dials Fada Type</li> <li>1 Power Rheostat</li> <li>1 Vernier Rheostat</li> <li>8 Binding Posts</li> <li>1 Closed Circuit Jack</li> <li>1 Filament Control Jack</li> <li>27 Ft. Insulated Tubing</li> <li>27 Ft. Tinned Bus Bar</li> <li>2 Fixed Condensers .006 Mfd.</li> <li>1 Fixed Condenser .00025 Mfd.</li> <li>1 Grid Leak 2 Megohms</li> <li>1 Diagram for Above Set</li> </ul> <p style="text-align: center; font-weight: bold;">Our Price \$32.50</p>	<p>Complete Parts for <b>Ambassador 1 Tube Set</b></p> <ul style="list-style-type: none"> <li>1 Ambassador Coil</li> <li>1 U. S. L. 23 Pl. Ver. Condenser</li> <li>1 Tillman 6 Ohm Rheostat</li> <li>1 Bell Bakelite Socket</li> <li>1 .00025 Fixed Dubilier Cond.</li> <li>1 3" Dial Fada Type</li> <li>1 7x12 Panel</li> <li>1 Single Circuit Jack</li> <li>6 Marked Binding Posts</li> <li>12 Ft. Tinned Bus Bar</li> <li>1 Diagram for Above Set</li> </ul> <p style="text-align: center; font-weight: bold;">Our Price \$12.25</p>	<p>Complete Parts for <b>Erla 1 Tube Set</b></p> <ul style="list-style-type: none"> <li>1 Hilco Varlocoupler</li> <li>1 Signal 23 Pl. Var. Cond.</li> <li>1 Bell Socket</li> <li>1 ERLA Reflex Transformer</li> <li>1 ERLA Audio Transformer</li> <li>1 .002 Fixed Dubilier Cond.</li> <li>1 .001 Fixed Dubilier Cond.</li> <li>1 .00025 Fixed Dubilier Cond.</li> <li>2 3" Dials Fada Type</li> <li>1 6 Ohm Tillman Rheostat</li> <li>8 Marked Binding Posts</li> <li>12 Switch Points</li> <li>4 Stops</li> <li>1 ERLA Fixed Crystal Detector.</li> <li>1 ERLA Blue Print</li> </ul> <p style="text-align: center; font-weight: bold;">Our Price \$19.45</p>
---	---	--

---

Complete parts for FADA 5 TUBE NEUTRODYNE SETS. ALL GENUINE FADA PARTS. LIST PRICE \$65.00. OUR PRICE \$51.00. Assembled in cabinet ready to operate, \$71.50.

Complete parts for FREED-EISEMANN 5 TUBE NEUTRODYNE SETS. GENUINE PARTS. LIST PRICE \$80.00. OUR PRICE \$62.50.

FADA 160 NEUTRODYNE. Factory made machines. LIST PRICE \$120.00. OUR PRICE \$89.50.

FREED-EISEMANN 5 TUBE NEUTRODYNE NR5. Factory made machines. LIST PRICE \$150.00. OUR PRICE \$125.50.

FADA NEUTRODYNE KIT—3 NEUTROFORMERS—2 NEUTRODONS. LIST PRICE \$25.00. OUR PRICE \$21.00.

FREED-EISEMANN NEUTRODYNE KIT—3 NEUTROFORMERS—2 NEUTRODONS. OUR PRICE \$22.50.

SHAMROCK KITS—3 NEUTROFORMERS—2 NEUTRODONS. OUR PRICE \$15.45.

SUPERDYNE COILS \$5.75.

## Montreal-California

(More than 2,500 miles)

### ON ONE MYERS TUBE

Remarkable radio reception is an everyday result with MYERS TUBES. Mr. W. E. Gerrard, 73 Pine Avenue, St. Lambert, Montreal, Canada, with a set designed and constructed by himself, and using only one MYERS TUBE, hears KDZB, Bakersfield, California.

Get distance with clarity. MYERS are the only tubes correctly designed for radio without bunched leads. Two types—for dry or storage battery. Insist on MYERS at your dealer's—otherwise send purchase price and be supplied postpaid. Write for free circuit diagrams.

(Actual Size)

\$5

EACH Complete with mounting clips ready to mount on your set; no sockets or extra equipment necessary.

E. B. Myers Co. Ltd.

Radio Vacuum Tubes.

240 CRAIG ST., W.  
Montreal, Canada



# Radio Digest

EVERY WEEK **Illustrated** PROGRAMS TEN CENTS

REG. U. S. PAT. OFF. AND DOM. OF CANADA

Published by the Radio Digest Publishing Company, Inc.  
510 North Dearborn Street  
Telephone: State 4372, 4373, 4374, 4375  
Chicago, Illinois

E. C. RAYNER, Publisher

Chas. F. Smisor, Editor Evans E. Plummer, Managing Editor  
H. J. Marx, Technical Editor M. W. Thompson, Associate Editor

Eastern Office, 611-12 Times Bldg., Times Square, New York;  
Telephone Bryant 4909, 10462

Member of the Audit Bureau of Circulations



PUBLISHED WEEKLY

### SUBSCRIPTION RATES

Yearly in U. S. and Possessions and Canada, \$5.00.  
Foreign postage, \$1.00 additional. Single copies, 10 cents.

Vol. IX Chicago, Saturday, May 3, 1924 No. 4

## Tax Adds Cost to Set

Another Burden Placed on the Home Entertainment  
THE ten per cent. tax on Radio apparatus as proposed by the senate tax committee would add approximately twenty-one per cent. to the retail cost of Radio receivers, according to Bowden Washington, well-known Radio engineer and manufacturer.

The tax would be a serious burden on a young industry and a detriment to a great public educational institution such as Radio has become.

The assessment would make costs almost prohibitive to many farmers, poor families, hospital invalids, and school boys and girls for whom Radio has become a source of enlightenment and entertainment. Radio is not a luxury, but has become almost as universal as the press and free speech.

Although it is the committee's idea to compel manufacturers to pay the tax, the assessment would naturally, as are other taxes, be passed on to the public. The distributing and selling formula would necessitate the added twenty-one per cent. more that the public would be asked to pay. Independent manufacturers who produce the great majority of sets now sold already pay heavy license fees, and the additional tax would constitute a burden that might prove a disaster to the young and not yet stabilized industry.

## Radio Appropriations and Bills

### Insufficient Amount to Carry on the Business

IF Secretary Hoover is to patrol the ether for fans and commercial and other interests, he may have to make a plea to the Senate appropriations committee.

Appropriations for Radio inspection, supervision and experimentation for the fiscal year 1924-25, were cut by over \$25,000 by the House appropriation committee, even after the figures submitted by the Department of Commerce had successfully run the "gauntlet" of the Budget.

Secretary Hoover had the approval of the Budget Committee for a total appropriation of \$180,278, for Radio administration, but this amount was reduced to \$158,778 by the House. The sum allotted is \$19,578 over the amount authorized for the current year, but this includes \$17,340 as pay for the Naval personnel handling Radio accounts, which it is proposed to transfer to Mr. Hoover's Department. The only additional money granted for field work, which has increased greatly during the past year, is \$2,000 instead of \$14,200 asked. Six extra assistant inspectors and three or four clerks were requested. No allotment for much needed apparatus for inspectors is made, although it is known that field workers have to purchase much of their own equipment in order to efficiently police the ether lanes, now congested badly with thousands of transmitters and approximately 20,000,000 fans filing complaints regarding interference. The Radio laboratory of the Bureau of Standards suffered also in a cut of \$4,320.

## Code for the New Listener In

### Some Rules if Followed Will Aid in Reception

IF the distant stations do not come in every night be satisfied to enjoy the nearer programs broadcast. Storm and weather change may interfere with your Radio evening. Remember there are many fine concerts coming.

For louder signals a longer antenna may be used, more tubes, higher plate voltage, more sensitive loud speakers and more careful receiver adjustment.

Loud signals are not always pleasing. Ones that will fill a moderate-sized room will give better satisfaction. If the large nearby stations come in too loud and drown out the others, a smaller antenna will help to tune them out. More selectivity may be had with a smaller condenser connected between the antenna and the ground.

A little patience in learning to handle your receiving set yields better tones. Try to become more familiar with your set and how it works.

## RADIO INDI-GEST

### I Have No Love but Radio

BY SIMPLY WADDLES

All alone with my Radio set,  
All alone sit I  
Tuning in stations (many I get),  
Often breathing a sigh.  
For I have no love but Radio  
Since my sweetie left me cold.  
Through life with Radio I'll go  
Until I'm gray and old.

Women are fickle. Their love is false,  
But you, old Radio set,  
Will stick by me. I'll hear your calls  
Till I settle my final bet.  
Your tubes burn out and you make mistakes  
But you're just human too.  
You may go wrong, but women are fakes  
And you—at least—are true.

I have no love but my Radio set  
Since my sweetie left me alone.  
Even if she'd take me back, you bet  
I'd just get another phone.  
And lest her head grew weary,  
A speaker large and loud,  
And we'd upset the theory  
That three is always a crowd.

### Mrs. Partington Speaks Out



Dear Indi: Mrs. Partington says, she's going to give somebody a "Piece of her mind" soon, if they don't stop starting all this talk about putting a big war tax on all Radio Receivers, like when the big war was on, so when you had to buy a little article from the drug store you had to pay twenty-five cents extra for it because the war tax stamp for 1/4 cent was onto it. She says if this tax is to build more air or to improve what we've already got, then maybe she would favor it. She thinks all Radio listeners had better organize together and use their patent right to vote their patent votes for their own patent Congress that won't meddle so much with

other folks' business but pay more mind to their own, and break a record by doing something once for the people who send them there and supports them by paying about all the taxes we feel like we are due to pay now. So, there.

SIGNING OFF.

### A Short Story for Long Men

Dear Indi: A man walked into the studio of a great broadcasting station. He asked the announcer for five minutes at the mike at 8:00 o'clock that evening. "Why?" asked the announcer. "Well," said the man, "I bought a Radio set because my wife is always yelling at me. She still yells when I try to listen in. She'll be tuning in at 8:00 tonight, and I want to talk back to her without giving her a chance to yell at me."

But the announcer, being single, could not conceive of a wife actually yelling. So the man left the studio in anger and started a campaign for married men announcers.

SPIDER WEBB.

### Our Own A. & Q. Dept.

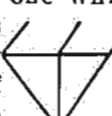
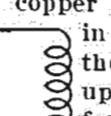
Dear Indi: I want a Radio and want to ask you if I can use any kind of a rake or only one which has 3 teeth like the one in the pictures like this  and do I have to have a long box to get long waves? Also I am wondering if I need a piece of tin or is a bucket best to put under where the grid leaks? Do I have to buy one of those funny things to put over my head with a pair of shoe laces with a key on the end to put in the hole, or can I hear if I put my ear up to that hole? Can I use a copper pipe condenser (moonshine) that looks like this  in the pictures, and tell me where I can get those round handles like on a safe so I can wind up the set to play the music? Oh yes, I almost forgot. Can I use candles instead of electric lights to keep it warm inside?

INS. U. LATION.

### We've Heard This Told a Little Differently

Dear Indi: My girl told me this the other night when I was calling at her house. Seems as though a young man was calling at his regular's and wanted to listen in. The following conversation took place:

He: "Let me tune in on your Radio set."

She: "No, I can't. It's Lent."

He: "Well, when are you going to get it back?"

FIDDLE D. DIAL.

### Shortage of Tubes, Shortage of Children

Dear Indi: When a friend asked "Dumb Cora" what her pa's idea was for building a set with seven tubes, she replied: "Well, you know we have a pretty large family, and it's nice for everyone to be able to hear at once."

PA.

### That Was Political Mud, Soozee

Dear Indi: The other night I tuned in on WJIA, Madison, Wis., and found they were all het up because it rained red mud up there the other day. Now I tell you what I think, Indi, it just goes to prove that the girls who walk home do go to Heaven, and when they get to the Golden, I mean Pearly Gates, being well brought up young women, of course they WASH THE MUD OFF THEIR SHOES. Yours for an early spring.

SOOZZEE.

## Close Harmony for the "King"



## Condensed

By DIELECTRIC

Station WHN figured in the "scandals of 1924" up to quite recently, when "King Telephone" issued a royal edict granting certain favors to the Loew State Theater that have occasioned surprise among the hoi polloi. It had been supposed all along that only the A. T. & T. company would be privileged to broadcast for pay, but now it appears the "King" has graciously extended the same right to WHN. What will the result be? Better advertising by Radio? It takes so long to announce "The Delicate Brown Brothers' Famous Cough Orchestra will next play—"

And now, my countrymen, fortune favors us Radiophans in a way we least anticipated. What can stay the hand of fate, when it is upheld by Congress! Just to think of millions of set makers, set buyers, tube and crystal consumers donating ten percent of good Radio cash to the Government on every purchase they make. What an opportunity to show the world how willing we are to sacrifice for the sake of those whose minds are enriched by eating candy!! Munching candy has a highly educational value, while listening to broadcasts of speeches from the President, lectures, good music and religious services is a luxury to be taxed. It is remarkable that Radiophony should be so free of plagues.

Canadian listeners expect announcements to be made in both English and French from their native broadcasting stations. In view of the numbers of French-speaking inhabitants, this is quite proper. But what of the man who must describe each move in a sporting event, first in one then another tongue, while the play goes on. Station CKAC in Montreal affords a good example of how ably this may be done. Hockey games from Ottawa were broadcast in the bi-lingual manner with but a couple of minutes lapse between play and description. Taxing enough.

Roxie deserves a great deal of credit for putting into practice what I have urged in these columns, i. e., setting afoot a plan to give war veterans the chance to hear Radio programs. He and his "gang" went to the Walter Reid Hospital in Washington to cheer up the buddies there with their singing and playing. Later Roxie started collecting a fund to be applied to the purchase of receiving sets for these men. The response has been all that could be expected, confirming my opinion that what was needed was someone to start the thing going. Let's boost it along.

Early last month listeners were informed of a special broadcast from SFR, the Eiffel Tower station in France, on a wavelength of 1780 meters. Very few fans in this country were prepared to receive so high a wavelength. Never before has a Radio concert from SFR been heard in this country and, so far as known, only one person caught this one. Mr. Moulton, a Radio operator, at Chatham, Mass., using a four tube set, listened to the concert from 6:10 to 7:15. The concert began at 7:00 p. m. and the power used on this occasion was 20 watts.

A very explicit and cogently worded explanation of the tube shortage was given by the "Tube Kings" to us henchmen a short time ago, in which it was made to appear that no shortage existed (at least none for which they were responsible), and we sighed and turned up our old filaments. Two professors in Philadelphia were experimenting with a two-element nitrogen-filled tube when it was made to oscillate and rectify without the use of any orthodox receiving apparatus. Should this lead to the use of a nitrogen tube for Radio purposes, no doubt it will be controlled by the "Tube Kings" for our benefit.



# How to Construct a Super-Heterodyne Receiver

## Part I—A Short Comment on Its Troubles

By Allen C. Forbes

IN THESE days of new inventions, some of us do the talking, some the writing and most of us do the listening and reading. We who listen hear the merits, advantages and disadvantages of the latest in Radio discussed from A to Z. Some of it soaks in and some of it goes right on through. Maybe it is best that most of it does pass on through, because if it stayed with us we would have our heads so chock full that we wouldn't be in a position to absorb any more from the next orator.

What I am going to try to do is to show, or rather tell, you how and what a super-heterodyne set is and also to give you sufficient information in a non-technical manner, so that you, too, can enjoy one of these sets and get some real pleasure in listening to a real set.

### Four Articles Describing Set

There will be four articles in this series wherein we will take up all the different phases of the construction and operation of the set. With the information contained in the articles together with the photographs and circuit diagrams, anyone that has already made a set or two should have no difficulty whatsoever in making an "eight-tuber." It is a very simple set to construct, provided, however, that you know what to do and do it.

Before going into the actual layout of the set, lets stop a minute and analyze a few of the various circuits now on the market. But hold on here—we are getting a little ahead of our story. Let's review the subject a little and see just what the super-heterodyne circuit is, why it is, what makes it so good and why is it better than any other circuit. Let's see why everyone says it is so wonderful. All right let's go: Now then, in the first place, along about the year 1913, we had practically discarded the vacuum tube as detectors for two reasons; because they were scarce and very hard to get and they were too expensive, required batteries, etc. We in the commercial service, thought we had better hang on to the good old crystal detector for a while longer. Then along comes the "arc" telegraph stations for use on long waves and great distances. We couldn't use the ordinary crystal detector for the reception of signals from these stations so we used a "ticker" which was nothing but a small motor driving a commutator to which were connected brushes leading to the head phones.

### Ticker Form of Reception

This "ticker" form of reception worked all right and then Mr. Reginald Fessenden came along and developed a miniature arc to fit in a receiving set and generate a high frequency oscillation. He called this a heterodyne receiver for use in the reception of signals from arc stations.

This form of reception was better than the ticker, but not so reliable as the operator had a great deal of difficulty in keeping the arc going and making it stable. You can easily see that this is, or was, the first form of the super-heterodyne circuit, as it was a circuit for the reception of Radio telegraphic signals, wherein a separate circuit, called the oscillating circuit or heterodyne circuit, superimposed another wave on the incoming signal and the resultant frequency was the one that produced an audible signal in the head sets.

It was only a short time after the commercial introduction of the heterodyne receiver in 1914 that the three-element vacuum tube made its appearance in com-

mercial form ready for work and we found that it could be connected up so as to regenerate, oscillate and "howl" and was ideally suited for arc reception. This "kinda" made the heterodyne principle fade away for a while until during the war experiments were made and in 1919 it was given to the world under the name of "A new method of short wave amplification" and since that time various additions and subtractions have been made to the original circuit but the principle remains the same and is readily recognized in all the various circuits claiming to be a super-heterodyne.

### Short Wave Over Long Distances

The thing most responsible for the development of the super-heterodyne set is

construction is undesirable. With extra care three and four stages can be used and on some trans-oceanic work we have used ten stages, but it is not generally satisfactory. Then too in using audio frequency amplification we are not increasing the signal strength as applied to the detector. Inasmuch as all detector tubes have a characteristic such that the strength of the audio signal depends upon the strength of signal impressed on the detector, by using audio frequency amplification we merely amplify the signal as delivered by the detector and are thereby limited.

### Radio Frequency Amplification

The disadvantages of amplifying the signal before detecting it, (we call this

producing complications in the form of controls which make the circuit difficult of operation by the average man.

The heterodyne circuit did not do this. It enabled us to design our apparatus on transformers for a particular frequency, thereby securing maximum efficiency. The usual method is to start with the incoming signal. We do this by placing a detector tube first in line. The signal then comes in, or rather it is induced into the loop, passes into the detector tube and is rectified. To understand the super-heterodyne principle you must follow it closely: Now the incoming signal passes through the coupling coil and into the oscillator coil, where the frequency of the wave generated by the oscillator tube

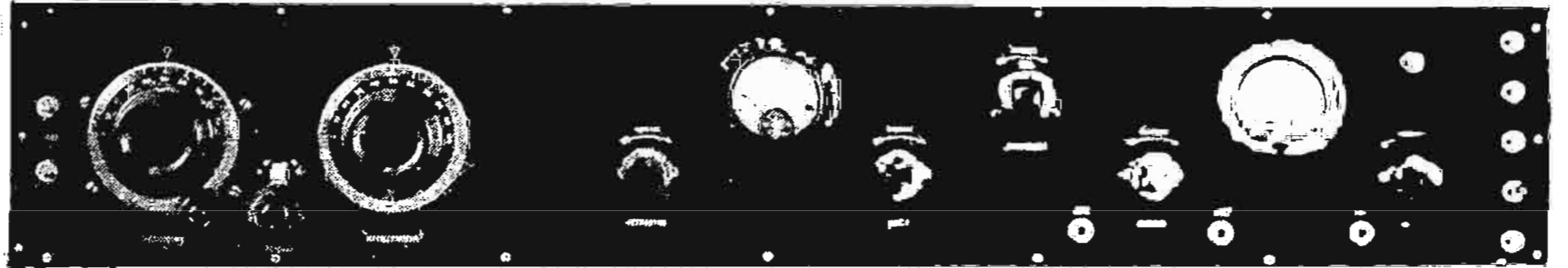

the very thing that we are struggling with now—namely the reception of short wave Radio telephone over long distances. For this reason, if for no other, it seems very logical that we should finally fall back on it and bring it up to a point where it will do what we want it to. The fellow who has only logged fifty or sixty distant stations and has never heard Havana (Cuba) or Spodunk (Somewhere) feels woefully out of place at a meeting of the fans. Now if he will pay strict attention to these articles and use a little common sense and good judgment he can build one of these supers and get in these distant stations.

It has been common knowledge with most of the old time Radio operators that short waves, those waves lying between 200 meters and 1,000 meters, carried very poorly over land or water for distances of over 300 miles. Of course, there has and always will be freak reception so we have always believed that amplification would solve the problem—but the question was what kind of amplification. When we only had crystals to deal with we tried various kinds of crystals in parallel, crystals in series, crystals on the roof and everywhere we could think of, and we tried chemicals. Then we tried relays to amplify the signal from the detector but none of these means proved commercially successful. We just naturally couldn't seem to amplify the signal from the crystal or chemical or magnetic detectors so we were stumped until the advent of the three element vacuum tube.

### Employing the Three Element Vacuum Tube

With the vacuum tube came audio amplification, Radio frequency amplification and super Radio frequency or the application of the heterodyne principle to assist amplification.

Now we approach the real meat of the super-heterodyne circuit. Follow closely: The disadvantages of audio frequency amplification are well known, due to the fact that the noise of the tubes themselves rises so rapidly. It has been determined by experiment that more than two stages of amplification using ordinary

Radio frequency amplification) lies in the construction of present day apparatus. Most manufacturers design their Radio frequency transformers to cover all the wave bands from 200 to 600 meters. In order to do this they sacrifice efficiency, because it's a very hard matter to make a transformer that will perform at maximum efficiency on all the broadcasting waves. Also because of the low capacity reactance existing between the various elements of the tubes most of the resistance and capacity couplings act as a nice little short circuit and prevents the building up of a potential in the external plate circuit. We can use and there has been introduced lately, a tuned impedance, which overcomes this objection but this has the disadvantage of in-

is super-imposed on it and passed on to the filter.

### Filter, Critical Part of Set

The filter is designed to be, and is, one of the most critical parts of the set. It consists of two coils, one in the first detector plate circuit and the other connected to the first intermediate frequency amplifying tubes' grid. Both of these filter coils must be adjusted to exactly the same frequency (wave length). This can be done by the use of fixed, or variable, condensers but be sure if using fixed condensers that the capacity of each matches the coil, exactly, there must be no guess work here, as most of the trouble encountered in the construction of a super-heterodyne set can be attributed to it or (Continued on page 22)

## Write for New Bulletin

Our new bulletin, just off the press, contains information of interest on battery maintenance, station calls and basement installation of batteries. Send for your copy today, also receive information on the Triple Duty Charger.

The type AB F-F battery charger charges 2, 4 or 6 volt A battery, auto battery, and B batteries up to 120 volts. Simple and fool proof. Charges a battery for about a nickel. Operates from light socket—no fuss or trouble.

Price—Type AB \$20; West of the Rockies, \$22. Type 6 for "A" or Auto Batteries, \$16; West of the Rockies slightly higher.

## The France Mfg. Co.

10420 Berea Rd., Cleveland, O.

London Office: 24 Maddox St., Melbourne, Australia  
P. O. Box 1727

## F-F BATTERY CHARGER

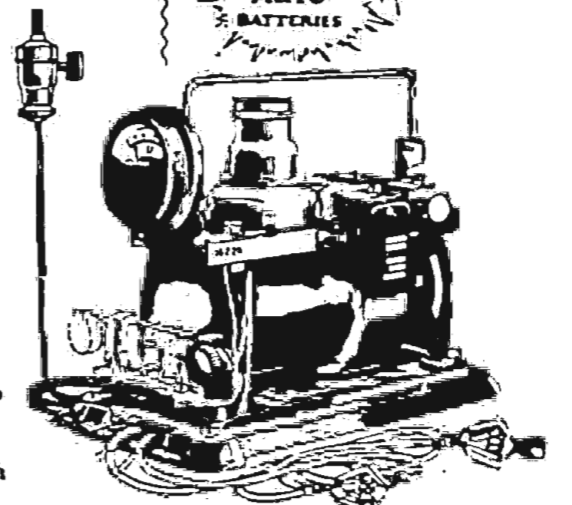
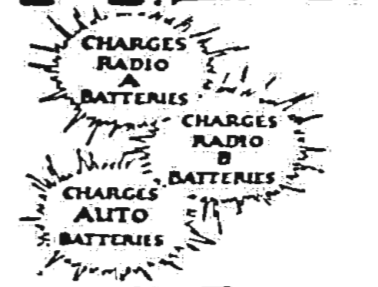

## The Twitchell Auxiliary Tuner

Patents Pending. Name Registered.

### MORE THAN A WAVE TRAP

A TWITCHELL AUXILIARY TUNER connected to any make of tube receiving set will positively cut out any local broadcasting or code stations so you may tune in all long distance stations any time regardless of local conditions.



Unlike any wave trap, THE TWITCHELL AUXILIARY TUNER does not ever decrease but in many cases increases the volume from distant stations.

These TUNERS are in daily use within 400 feet of large broadcasting stations and enable their owners to easily and completely cut out the local station and bring in distant stations at any time on a loud speaker.

This instrument will also enable you to bring in programs sent out on longer waves than you can tune in without it, thus bringing all the broadcasting stations within the wave length range of the many sets of limited range now in use.

Copyrighted diagram of this tuner, 50c, or with all parts, \$9.00. Complete instrument in walnut cabinet, ready to use, \$15.00.

A New and Wonderfully Efficient Coil for the Reinartz circuit for those who want the best. Price \$4.00, or with blueprint for either one or three tubes, \$4.50.

This circuit brings in both coasts loud and clear and is the most successful Reinartz modification yet produced.

All goods prepaid. These instruments are easy to build, easy to operate. Everything clearly shown

S. A. TWITCHELL

MINNEAPOLIS, MINN.

1925 WESTERN AVENUE

## World's Biggest Battery Bargain

FREE  
Guaranteed in Writing for 2 YEARS

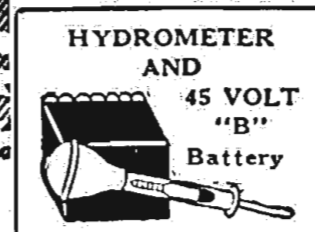

HYDROMETER AND 45 VOLT "B" BATTERY  
FREE  
Save 50%



Thousands of Radio Digest readers will profit by this amazing offer. They will buy the famous 2-year guaranteed World Battery at the lowest price ever quoted. With it they will get a hydrometer and a 45-volt "B" battery FREE. And they get the best battery built, with 2-year iron-clad guarantee.

Quality Not Cut to Maintain Price  
Special 200-hour Re-chargeable Storage Batteries

2 Volt for WD-11 and 12 Tubes.....	\$ 5.00
4 Volt for UV-199 Tubes.....	8.00
6 Volt 60 Amp.....	8.50
6 Volt 80 Amp.....	10.00
6 Volt 100 Amp.....	12.50
6 Volt 120 Amp.....	14.50
6 Volt 140 Amp.....	16.00

5% Discount for Cash with Order.  
SEND NO MONEY

Just clip this ad and mail with your name and address. Shipment made same day order is received. When battery arrives, inspect it. Read our 2-year guarantee before paying C. O. D. express charges. Get the 45-volt "B" Battery and Hydrometer FREE. Clip the ad and send your order NOW.

WORLD BATTERY CO., DEPT. L, 60 E. Roosevelt Rd., Chicago, Ill.

# World

Send Your Order Today



### FIXING WHAT'S WRONG

(Continued from page 13)

Figure 3 gives a layout of the front of a typical five-tube receiver, showing the arrangement of controls. When the dials have been carefully adjusted to give the loudest burr signals, it will be noticed that all three dials have almost identical settings.

The next step in the balancing-out program consists in removing the first Radio-frequency amplifying tube from its socket and readjusting the three dials carefully for maximum strength of signal. A small piece of paper is placed over one of the filament contact pins of the tube mentioned above, after which the tube is again inserted in its socket, care being exercised to see that the paper remains on the contact pin. In this condition, the plate and grid of the tube will be connected in the circuit, but even though the rheostat is turned on the filament will not light because the paper over the contact pin prevents contact. It is cautioned not to turn off the rheostat, because the balancing process should neutralize all capacity effects, including filament battery connections.

With the tube rendered inoperative as stated, faint signals will still be heard in the phones, due to the existing capacity coupling, which is to be neutralized. The signal strength is adjustable over quite a range by moving the metal tube of the first neutrodon. The correct adjustment is for minimum or inaudible signal. Under these circumstances, removing the tube from its socket will permit loud reception, and replacing the tube, with the paper still in place, will cause the signals to disappear. The neutrodon, after being carefully adjusted for minimum signal, should be permanently fastened by soldering the metal clamp to the tube.

Having finished the neutralizing adjustment for the first Radio frequency amplifying tube, the same procedure should be carried out for the second Radio frequency tube, having the other tubes, including the first Radio frequency tube, operating with filaments lit. The second Radio frequency tube should be put in its socket, after having put a piece of paper over its filament contact pin to prevent the filament from heating up. The instructions for balancing-out the first tube should be repeated for the second.

#### Adjusting for Maximum Signal Strength

Care should be taken when regulating either neutrodon to see that all three dials are adjusted for maximum signal strength before final neutralization is effected. The

point of complete neutralization will be readily recognized, because signals will come in quite strong if the metal tube is moved even a small amount to either side of the correct balanced-out position of the neutrodon. Usually when properly adjusted the metal tube will be about in the center of the neutrodon. It will be noted that the neutralizing condensers are provided with three terminals. Whenever a good minimum signal balance cannot be obtained with the connections made to the two end terminals, it is desirable that one of the neutroformer connections be made to the middle terminal. In this way, greater capacity range is afforded the neutrodon and by proper re-balancing a good minimum signal should be secured.

In checking up on the adjustment, with the receiver carefully connected up, the operator should tune in a nearby broadcasting station, and then by adjusting the dials over the range of the receiver, the broadcast signals should be heard without any of the howling, whistling or beat notes, usually accompanying a state of regeneration or oscillation. Under such circumstances the circuit is not functioning in accordance with the neutrodyne principle, and, consequently, the receiver should be carefully readjusted.

(TO BE CONTINUED)

### SUPER-HET DETAILS

(Continued from page 21)

coils, unmatched condensers, or condensers that do not match the coils to which they are connected.

The function of the filter is to stop all those frequencies below or above the one it is designed to pass. In other words, if these coils have sufficient inductance and capacity in the form of condensers to pass one hundred kilocycles (3,000 meters wave length) then this frequency is the only one that will pass. It is easily seen then that with the proper filter in our circuit we can't help but have a selective set. On the other hand if the filter is not tuned to the proper wave length that we wish to pass, then we cannot get extreme selectivity.

From the filter we pass to the first intermediate frequency amplifier tube then into the first intermediate frequency amplifying transformer. Our problem now is to get a transformer that will give us maximum amplification.

We have three choices of amplification—namely: Resistance coupled, air core transformers, fixed or variable and iron core transformers.

The resistance coupled method is now obsolete and has been discarded for more improved methods because it is non-selective and in the majority of cases noisy.

The air core transformers, while still used, will not give the high ratio of transformation desired and if made variable, introduce additional controls which make for complicated operation.

The iron core transformer, in spite of all objections, seems to be more ideally suited to the amplification of the intermediate frequency because the iron introduces resistance into the circuit and increases the ratio of inductance to capacity. The iron giving a powerful magnetic flux makes for more stable and quiet operation.

From the first intermediate frequency

transformer the current passes through the second tube to the second transformer, through the third tube to the third transformer, then to the second detector and to the first audio frequency transformer then to the first audio amplifying tube through to the second audio transformer to the second audio amplifying tube and into the head set or loud speaker.

This article has now taken you through the super-heterodyne and shown you the function of each tube and piece of apparatus. The next article will give the list of parts necessary for the complete set and the panel layout will be given at the same time so as to show where the different controls are located and give you the size of the set.

(TO BE CONTINUED)

## S. HAMMER RADIO CO.

303 Atkins Avenue, Brooklyn, N. Y.

### NEW COCKADAY DISTORTIONLESS AMPLIFIER

Complete Parts Exactly as Specified by Mr. Cockaday

List Price	Our Price	List Price	Our Price
\$4.00 4 Na-Aid Sockets	\$2.60	\$12.50 1 Pr. Como Dup. P. P.	\$10.00
2.00 2 Marco Jacks	1.50	7.00 1 Amertran, 5 to 1	5.80
2.50 2 Amsco 20 ohm Rheostats	2.00	.45 1 Dubilier .00025	.40
2.00 1 Bradleyohm No. 25	1.80	3.80 6 Dubilier .005 Cond.	3.30
1.85 1 Bradleyleak	1.70	2.00 10 Eby Binding Posts	1.80
		2.25 1 Panel 7x12	1.95

# \$32.00

List Price \$40. OUR PRICE for above complete parts. The Above Parts May Be Bought Separately

**\$120 FADA NEUTRODYNE**  
Set No. 160  
Wired in Fada's Own Factory  
None shipped C.O.D. **\$88.00**

**\$65.60 FADA KNOCKDOWN**  
Parts No. 167-A  
Sealed in Fada's Factory  
Complete parts. None Shipped C.O.D. **\$49.00**

**COCKADAY**  
Four-Circuit Receiver  
3000 MILES  
Genuine complete parts exactly as specified by Mr. Cockaday.

- 1-Cockaday Precision Coil
  - 2-Amsco 26-Pl. Cond.
  - 2-Amplex Grid-Densers
  - 1-Bradley Leak, 1/4 to 10 meg.
  - 5-Melco Sockets
  - 1-Amsco 6 ohm Rheostat
  - 3-Amsco 20 ohm Rheostats
  - 1-Pacent Single Jack
  - 2-Pacent Double Jacks
  - 2-Amertran Transformers
  - 1-Como Push-Pull Transformer
  - Input
  - 1-Como Push-Pull Transformer
  - Output
  - 2-Switch Levers
  - 11-Switch Points
  - 2-Switch Stops
  - 1-Dubilier Condenser—.0005
  - 1-Dubilier Condenser—.00025 with Mount
  - 1-Durham Variable Grid Leak
  - 3-Lavite Resistances—48,000 ohms
  - 1-Amsco 400 ohm Potentiometer
  - 1-7x24 Panel
  - 1-3"x2 1/4" Sub Panel
  - 1-1"x12" Panel
- OUR PRICE **\$53.00**

5-Tube Neutrodyne Set, wired complete in a mahogany cabinet—Genuine FAOA Parts. **\$70.00**

**4000 Ohms N&K Imported Phones MODEL D**  
List \$8.50 **\$5.85**

\$100 Melco complete parts including walnut cabinet for the Superdome Receiver  
The Ultimate in Radio Sets **\$85.00**

**8 TUBE—Type SH 8-1 Super Heterodyne**  
Receptad Kit Consisting of 3 R.F. Trans., 5,000 to 25,000 meters, Type R.F. 1718, 1 Audio Trans. for 1st stage, Type ATX, 1 Audio Trans. for 2nd stage, Type AT3, 2 1 Mfd. By-pass Condensers, Type C 1000, 1 Tuned Filter Coupler, Type SW 21, 1 Super-Heterodyne Manual

- ADDITIONAL PARTS**  
1 Panel 14x8x36 Bakelite, drilled and engraved  
1 Terminal Panel 14x8x1 1/2, 1 .001 Mid. Cardwell Condenser and Univernier  
1 .0005 Mid. 23 plate Cardwell Vernier  
8 Sockets, Federal or General Radio  
3 Rheostats, 10 ohm, Gen'l Radio  
2 Rheostats, 6 ohm, Gen'l Radio  
1 Potentiometer, 400 ohms, General Radio  
3 Grid Condensers and Leaks  
2 .00025 Fixed Dubilier Cond. 1 .002 Fixed Dubilier Condenser  
1 .006 Fixed Dubilier Condenser  
1 2 Circuit Federal Jack  
1 Single Federal Jack  
1 Switch, Cutler-Hammer  
List Price **\$125.00**. Our Price **\$92.50**

**SUPER VALUES**  
**SUPER-HETERODYNE**  
NEW AND IMPROVED TYPE  
RESISTANCE COUPLED—NO TRANSFORMERS  
MODEL D  
Complete Blue Prints—Consisting of Instrument Layout and Wiring Diagram. Our Number 501-502D. Price **\$2.00**

**COCKADAY'S AUDIO FREQUENCY AMPLIFIER DISTORTIONLESS**  
Here Are the Parts You Will Need  
A—1 Bradley Ohm No. 25 (25,000 to 250,000)  
B—1 Bradley Leak, 1/4 to 10 Meg.  
C and D—2 Amsco 20-Ohm Rheostats.  
E, F, G, H—4 Naaid No. 400 Sockets.  
I—1 Amertran 5 to 1 Transformer.  
J—1 Como Input Transformer.  
K—1 Como Output Transformer.  
L—1 Martin Copeland Double Jack.  
M—1 Martin Copeland Single Jack.  
N—1 Dubilier .00025 Mfd. Condenser.  
O—3 Dubilier .005 Mfd. Condensers.  
P—3 Dubilier .005 Mfd. Condensers.  
Q—1 7x12 Composition Panel.  
R—1 7x12 Mahogany Cabinet.  
S—10 Eby Engraved Binding Posts.  
T—1 Connection Block.  
U—1 Insulated Tubing, Solder, etc.  
Our Price **\$30.00**  
WE GIVE A 20% DISCOUNT on All Standard Radio Apparatus Not Listed Above  
All Mail Orders Shipped Promptly Send Money Order, Including Postage  
The Radio Mail Order House—Known for Low Prices  
WRITE FOR OUR CATALOG "B"

**HANES-ZENER**  
1480 Broadway, Corner 42nd St., New York City

**The Church AUTOMATIC TEMPLATE**  
**\$1 LIST**

Just three taps

A TWIST of the thumbscrew, three taps with a hammer—and you're ready to drill your panel accurately for ANY instrument. No more spoiled panels!

The Church AUTOMATIC TEMPLATE eliminates rulers, scribes, and dividers. Get it from your dealer, or write us direct (Room 607) if he cannot supply you.

BUY IT TO-DAY

NAT'L DISTRIBUTORS  
**CLARK & TILSON, INC. ~1 East 42 Street, N.Y.C.**

**\$80 Freed-Eisemann**  
Parts for  
**5 TUBE NEUTRODYNE**  
Set K.D. 50  
None Shipped C. O. D. **\$61.00**

**\$150 Freed-Eisemann**  
**NEUTRODYNE**  
Model N.R.-5  
None Shipped C. O. D. **\$122.50**

**COMPLETE STANDARD PARTS FOR Neutrodyne 5-Tube Set**

- 1 7x26 Panel, Drilled
- 1 Single Sockets
- 1 Triple Socket
- 2 Neutrodons
- 3 Neutroformers
- 2 Jefferson Transformers
- 1 Battery Switch
- 3 4" Dials, Fada Type
- 1 Power Rheostat
- 1 Vernier Rheostat
- 8 Binding Posts
- 1 Closed Circuit Jack
- 1 Filament Control Jack
- 27 Ft. Insulated Tubing
- 27 Ft. Tinned Bus Bar
- 2 Fixed Condensers, .006 Mfd.
- 1 Fixed Condenser, .00025 Mfd.
- 1 Grid Leak, 2 Megohms
- 1 Diagram for Above Set

Our Price **\$30.50**

**PHONES**

- \$ 5.00 Turney, 3000 ohms... \$ 2.75
- 12.00 Western Electric ... 8.75
- 6.00 Brandes Superior ... 4.70
- 12.00 Baldwin Type C ... 7.85
- 7.00 Federal ... 4.85
- 5.50 Stromberg Carlson ... 4.50
- 12.00 Dr. Seibt 6000 ohms... 5.75

**LOUD SPEAKERS**

- \$30.00 Music Master ... 24.00
- 35.00 Magnavox, New Type ... 28.50
- 36.00 Radiola U. Z. 1320... 30.00
- 10.00 Brandes Table Talker. 8.50
- Baldwin Unit ... 4.65

**RHEOSTATS**

- 1.00 Fada 30 ohm ... .90
- 1.50 Federal 25 ohm ... 1.25
- 1.00 Amsco 6 ohm ... .85
- 1.25 Amsco 20 ohm ... 1.00
- 1.30 Amsco 30 ohm ... 1.10
- 1.50 Cutler Hammer 6 ohm Vernier ... 1.15
- 1.50 Cutler Hammer 30 ohm ... 1.15
- .90 Klossner 6 or 30 ohm ... .80
- 1.00 Pacent 6, 20 or 30 ohm ... .90
- 2.00 Filkostat ... 1.85
- 1.85 Bradley-Stat ... 1.70
- 1.85 Bradleyleak ... 1.70

**23-PLATE**

- 6.50 Hammarlund ... \$ 5.85
- 5.00 U. S. Tool ... 3.60
- 5.00 U. S. L. ... 3.45
- 4.50 Amsco ... 3.35

**43-PLATE**

- 5.50 Hammarlund ... 6.25
- 5.50 U. S. Tool ... 4.05
- 5.00 Amsco ... 3.95
- 4.50 Amsco 17-Pl. ... 3.35
- 5.50 Amsco 26-Pl. (4" dial) ... 4.10
- 3.00 Compensating Condenser ... 2.65

**VARIABLE CONDENSERS**

- 11-PLATE
- \$ 2.00 Signal or U.S.L. ... 1.40
- 1.80 Amsco ... 1.30

**23-PLATE**

- 2.50 Signal or U.S.L. ... 1.60
- 2.30 17-Pl. Amsco ... 1.65
- 2.50 Amsco ... 1.95

**43-PLATE**

- 2.75 Signal or U.S.L. ... 1.65
- 2.50 Amsco ... 2.75

**VERNIER CONDENSERS**

- 11-PLATE
- 6.00 Hammarlund ... 4.95
- 4.50 U. S. Tool ... 3.50
- 4.50 U. S. L. ... 3.10
- 4.00 Amsco ... 2.95

**GENUINE Lavite Resistance**  
48,000 Ohms, Special...**\$1.10**

**AMPLEX GRID DENSER** **80c**

**TRANSFORMERS**

- 7.00 Federal No. 63 ... \$ 5.25
- 5.00 Acme ... 3.75
- 5.00 All-American ... 3.80
- 7.00 Amertran ... 5.50
- 12.50 Como Duplex P. P. ... 9.75
- 12.50 Modern Push-Pull ... 9.75
- 5.00 Eria ... 4.15
- 5.00 Eria Selectorformer ... 4.25
- 12.00 All-American P. P. ... 10.00
- 5.00 General Radio ... 4.55

**Genuine 4 Tube Superdyne**  
More powerful than a 6 tube naval receiver. Easy to build.  
Complete Parts  
1-Superdyne Coupler  
2-23-Plate Variable Condensers, .0005 mfd.  
1-Variable Grid-Leak  
1-.00025 mfd. Fixed Condenser  
3-Rheostats  
2-Switch Levers  
2-Switch Points  
4-Switch Stops  
4-V. T. Sockets  
2-Acme Audio Transformers  
1-Single Circuit Jack  
1-Double Circuit Jack  
7"x24" Panel  
Bus Wires, Spaghetti and Diagram  
Our Price **\$27.50**

**POTENTIOMETERS**

- 1.25 Pacent ... \$ 1.10
- 1.50 Amsco ... 1.25
- 1.50 Cutler Hammer ... 1.15
- 1.50 Klossner ... 1.25

**DIALS AND SOCKETS**

- 3" Amsco Bakelite ... .45
- 4" Amsco Bakelite ... .80
- Red Socket ... .65
- Melco Socket ... .60
- Bakelite Socket ... .45
- Chelton Socket ... .65

**JACKS AND PLUGS**

- Pacent Double Jack ... .75
- Danstrom 6 Way Plug ... 1.25
- Pacent Single Jack ... .60
- Federal Single Jack ... .65
- Cleo 2 Way Plug ... .55
- Weston lug ... .60c

**MISCELLANEOUS**

- Fathé Rheostats ... 7.95
- Ambassador Coils ... 5.25
- Cockaday Coils, Precision ... 4.50
- Cockaday Coils, Eastern ... 3.35
- \$2.00 Reinartz Coil ... 1.40
- Eria Crystals ... .45
- Brush Lightning Arrestors ... 1.75

ALL MAIL ORDERS SHIPPED PROMPTLY. Orders over \$5.00 will be shipped prepaid. Money orders or C. O. D. Not insured unless insurance charges included. Write for Price List.



# Regeneration Sets Do Not Steal Signal Strength

## Scientists Suggest That Sun's Dust May Be Cause

By M. W. Thompson

*Editor's Note—The address by Professor Pickard is several thousand words in length and of a highly technical nature. Our associate editor, Mr. M. W. Thompson, heard it and analyzed it as printed below, in terms which all may readily grasp. The interpolated explanations and practical applications of the facts presented, are his.*

SCIENCE, ever probing and analyzing, tireless and persistent, is about to untangle and explain another of nature's great mysteries. In Radio science, two important phenomena, "static" and

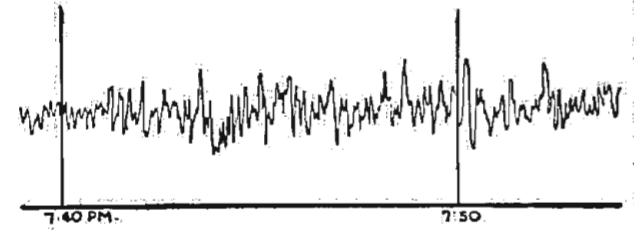

"fading" have so far withstood every effort to solve their cause and source. That the objectionable "fading," or as it is sometimes called "swinging" and "soaring," will soon no longer be a mystery but understood and possibly controlled, was the unanimous opinion of leading Radio engineers who attended the last meeting of the Institute of Radio Engineers.

At the meeting, which was attended by such renowned scientists as Dr. Louis Cohen, Dr. E. E. Mayer, General Russell, Professor Morecroft, Dr. DeForest, General Squier and Dr. Alfred Goldsmith, a paper on fading was read by Professor Greenleaf W. Pickard which outlined his experiments, tests and observations over a period of fifteen years. Professor Pickard is consulting engineer to one of America's leading manufacturers of precision equipment and is well-known for his discovery of the crystal detector, and countless other inventions.

### Lantern Slides Used to Illustrate

Listening to his address, which was illustrated with scores of lantern slides, one could not but be impressed by the untiring patience and devotion to science of a man who could take the records day after day of scores of stations, carefully noting every infinitesimal variation in

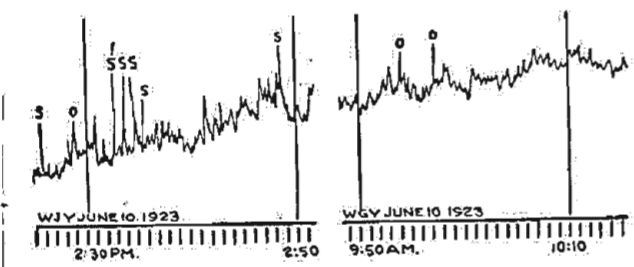

signal strength hour after hour, as well as every factor—such as operation of other sets nearby and of spark stations—that might affect his observations.

Well-known stations, such as KDKA, WNAC, WGY, WDAP, WCAP, WBAP and WOC were chosen by the professor as the most fitting for study, as understanding of their fading would benefit the greatest number of listeners. After describing to his assembled colleagues the apparatus used and leaving no doubt in anyone's mind as to the accuracy of the data gathered through it, the famous scientist went on to show some of the records made, a few of which are illustrated here.

### Two Important Facts

It is by careful study and analysis of such charts or graphs, gathered over a long period of time, and hundreds of hours of patient listening, that deductions and theories are formed which lead to the truth. Two important facts have been settled, the first being, to quote from his address: "If we continue our attention to frequencies between 500 and 1,500 kilocycles, that is, to the band now principally filled with Radiophone broadcasting, and to overland transmission at distances between 100 and 1,000 kilometers (62 to 620 miles), we find that the average mid-winter intensity (signal strength) is about five times greater than in midsummer." There you learn why, in summer, you cannot hear that distant station which rolled in so wonderfully in January.

A second portion of his address tells us that, "The principal change from day to night is an increase in field intensity (signal strength); the upper limit of the nighttime field . . . maybe ten, a hundred or even, on occasion, thousands of times greater than the daytime intensity, depending upon the distance and the character of night." Which explains why frequently Mrs. Listener cannot hear that afternoon lecture on baking or care of the complexion from that distant station which her husband brings in so clearly when he comes home in the evening.

### Receiver Is Exonerated

These two calculations, while not pertaining closely to the phenomena of fading,

were apparent during the tests and the final analysis. The regenerative receiver is exonerated from one of the many crimes ascribed to it by another portion of Professor Pickard's talk when he states: "A very odd explanation of these variations (changes in signal strength) has been gaining much vogue in the popular scientific press, to the effect that they are due to other receivers in the neighborhood, particularly if these happen to be of the much maligned single-circuit regenerative variety. I have many records of transmission, principally made by audibility meter measurement, which run back over fifteen years, when there were far less receivers than at present. These records show exactly the same short period variations (decreases in strength for three to fifty seconds) that now exist, so that this explanation does not seem very plausible. However, I have recently made a number of records of reception from distant stations under conditions of severe exposure to nearby regenerative receivers of which one of the illustrations is typical.

In this record, the broken heavy baseline indicates periods when a single-circuit regenerative receiver in the same house with my recording set, and with a fair-sized open antenna adjacent to the one employed with the recording set, was in operation. Full regeneration was used almost to the point of oscillation, but this record, like several others which I have made with different exposures of antennas, shows no effect whatsoever."

### Neighbor's Receiver Interferes

There you have it. If your neighbor

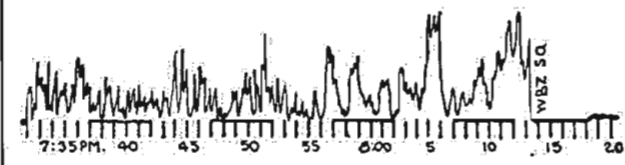

permits his set to oscillate and causes the rising and falling whistle in your headphones, get after him, but he is not responsible for the sudden falling off of signal strength in some program to which you may be listening.

The deductions formed by Professor Pickard as to the cause of fading are most interesting and, while not as yet proven facts, remain as a theory to be proved or disproved by his own future work and that of his contemporaries. Just so much energy is radiated by a broadcasting station and, if part of that energy is absorbed or weakened by a condition of nature, less energy reaches your receiver. Assuming that it is absorption, what is it that absorbs? To again quote from his masterful presentation of the tests. "Absorption can only be explained as due to ionization (too many positively charged particles) and . . . one difficulty in the past has perhaps been our tendency to attribute too much of the ionization to the effect of direct sunlight, and too little to the effect of alpha particles shot out by the sun, which continually fall in drifting clouds into our atmosphere. These charged particles may arrive intermittently and at short intervals, perhaps in groups of small cloudlike masses, and before the outer limit of our atmosphere is reached, the earth's magnetic field begins to deflect and comb them out along its own direction.

This (combing) process continues, perhaps down to an elevation of some 150 kilometers (94 miles) or less, eventually drawing these clouds out into long streamers in a south to north direction. Then, perhaps, these streamers are captured by the high level air currents, which cover the United States at heights of between 100 and 20 kilometers (63 and 13 miles), drift slowly from west to east, and, finally, they become subject to the stronger and varying low level winds."

### Reflecting Waves Back to Earth

This hypothesis is well illustrated in the sketch and the result is that the streamers of alpha particles from the sun could act, now as a gigantic mirror which reflects Radio waves back to earth causing interference and weakening, and then again like a huge grating which would permit the Radio waves to enter and would absorb them. This upper stratum,

would be constantly varying, at one moment absorbing, at another reflecting, and thus cause the constant change in signal strength apparent in the graphic record. During the day, the "beta ray", adding to the ionization, would tend to make the grating uniformly absorptive, while at night, when they are not present, the grating is more refractive (capable of reflecting) and signals would be stronger though generally stronger than in the daytime.

It must be understood that this hypothesis is not accepted a fact, to quote more Professor Pickard: "I am sure

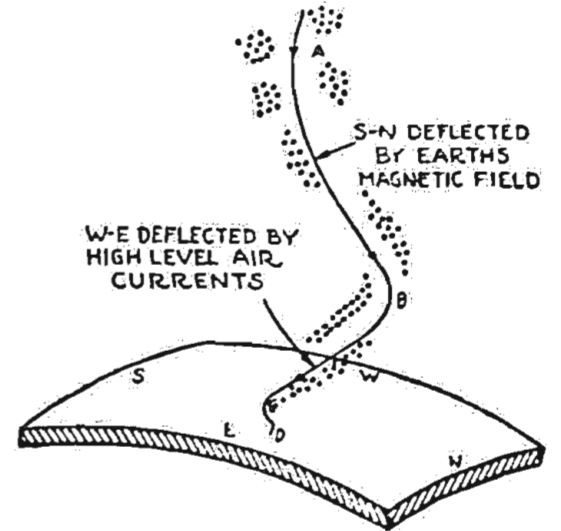

you will agree with me as to the utility of an hypothesis. . . . It is at least something concrete, and if it stands the attack of new facts, and the further analysis and correlation of our present knowledge, it may be the stepping stone to the truth." It is such years of investigation that are the heart of science, are what materially advance civilization, and Professor Pickard cannot be too highly congratulated on his contribution to Radio knowledge.

**The "Goode" Two-o-One**

**A**

*Le Ton d'argent*

**Guaranteed**

**BY MAIL ONLY \$2.39**

Postpaid

**QUARTER AMPERE AMPLIFIER-DETECTOR RADIO TUBE**

**GUARANTEED SATISFACTORY**

All "GOODE" Tubes Sold Direct to the Consumer—No Dealer Profits

ONE—"Goode" Detector-Amplifier ..... **\$2.39**

THREE—"Goode" Detector-Amplifiers ..... **6.42**

(All postage prepaid)

The "Goode" Two-o-One A Tube amplifies or detects. It is a quarter ampere, six volts, standard base silvered tube.

Send express or postal money order or New York draft to—

**The Goode Tube Corporation**

Incorporated

**EVANSVILLE INDIANA**

**SHAMROCK**

FOR SELECTIVE TUNING

**TUNED RADIO FREQUENCY KIT**

Can be used in any Tuned Radio Frequency circuit.

**SHAMROCK**

SHAMROCK MANUFACTURING CO. NEWARK, N. J.

**You'll Be Neighbor to Havana**

WITH the new Shamrock Kit you can build a set that pulls in stations 3,000 miles away. These revolutionary kits contain two of our new balancing condensers and three Shamrock air core transformers mounted and properly balanced on U. S. Tool condensers, made expressly for Shamrock.

**List Price \$20**

Inspect this kit at your dealer's today. If he hasn't it in stock, send us the coupon below.

**SHAMROCK MANUFACTURING CO.**  
Dept. 26, Market St., Newark, N. J.

**SHAMROCK**

FOR SELECTIVE TUNING

SHAMROCK MANUFACTURING CO.,  
Dept. 26, Market St., Newark, N. J.  
Gentlemen: Send me detailed information on the Shamrock Kit.

Name .....

Address .....

Dealer's Name .....

**BLUE PRINTS**

MAKE YOUR OWN SET

**Special Offer**

**5 Books 2.00**

For \$2.00

**NEUTRODYNE**  
Five Tube Receiver  
Full Assembly Details  
Blueprints  
Tuning Instructions

**REINARTZ**  
Three Tube Receiver  
Detector and Two Stage Audio  
Frequency Amplifier  
Assembly Details  
Tuning Instructions  
Blueprints

**MILOPLEX**  
Three Tube Receiver  
Detector and Two Stage Audio  
Frequency Amplifier  
Assembly Details  
Tuning Instructions  
Blueprints

**REFLEX DE LUNE**  
Three Tube Receiver  
Full Details for Assembly  
Blueprints  
Tuning Instructions  
How to Make a Loop Aerial De Lune

**FLEWELLING**  
Three Tube Receiver  
Detector and Two Stage Audio  
Frequency Amplifier  
Assembly Details  
Tuning Instructions  
Blueprints

**ONLY 50 CENTS EACH**  
All five blueprints for \$2.00  
Send Only Money Orders. No Checks or Stamps. Coins at Your Own Risk.

**RADIO DIGEST PUBLICATIONS**

510 North Dearborn St.  
Chicago, Ill.

Please send me the Special Offer of 5 Books. I am enclosing M. O. for \$2.00.

Name .....

Address .....

City ..... State .....



**THIRTY MINUTE A-B-C**

(Continued from page 19)

so that the current supply is interrupted or fluctuated somewhat as a microphone operates, that is to say, by this variable battery resistance. This is chemically caused and results in a so-called noisy B battery because a rumbling is heard in

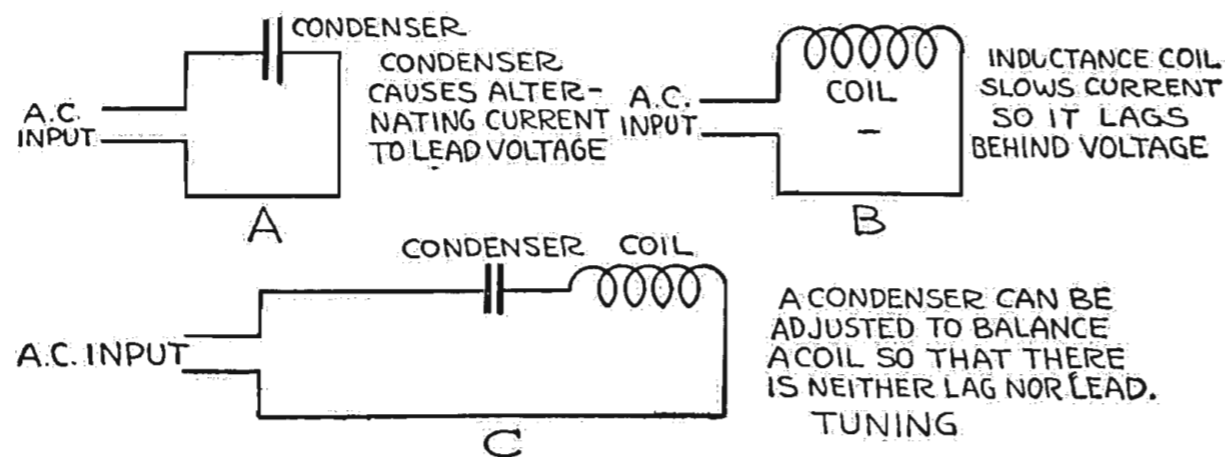

Figure 76.

the headset from the fluctuating plate voltage. Dry cells run down with time even when not used owing to drying up and polarizing in the cells. A B battery of good construction will sometimes last

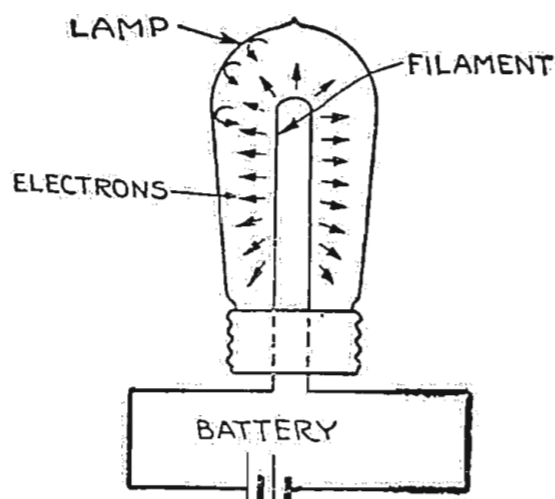

Figure 77.

over a year while a poor one may run down in a month's time.

A battery is shown in diagrams by a long line separated from a short heavier line. If connected to a coil of many turns

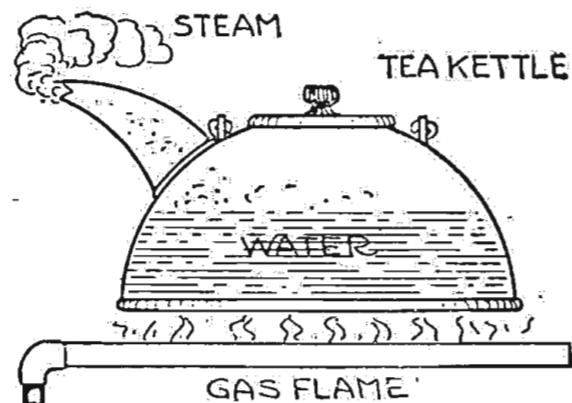

Figure 78.

as in Figure 73, a magnet is formed and can be used to attract or repel a permanent magnet. Electric motors are operated on this principle. If an iron core

or cylinder is placed in one end of a coil, Figure 74, current in this coil or solenoid will pull the iron core into it. An iron core concentrates the lines of force set up by the coil. Telephone receivers and loud speakers utilize these principles.

Electricity is electricity, whether called alternating or direct. A direct current flows at a steady applied voltage, Figure

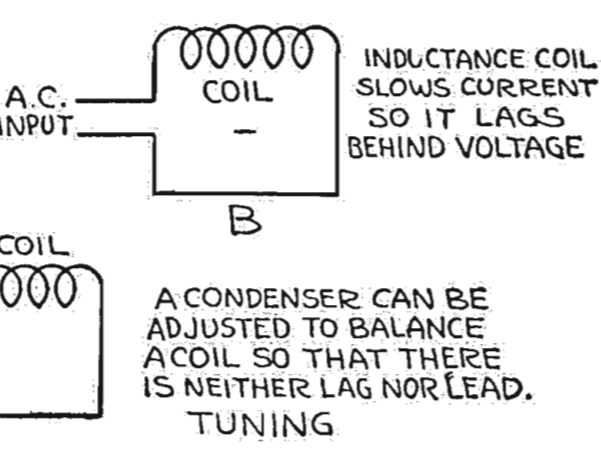

Figure 75.

75, whereas in the case of an alternating supply, the direction is regularly reversed back and forth. This can be fixed in mind

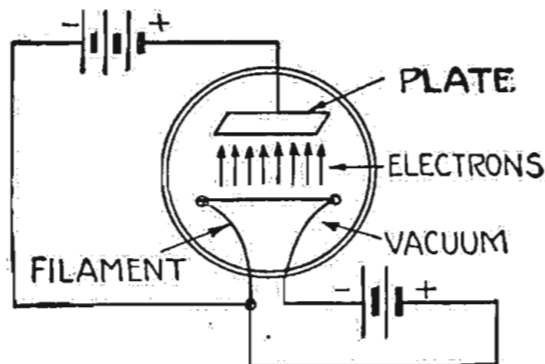

Figure 79.

by analogy to two different kinds of saws. A band saw cuts wood by moving in one direction. A buck saw cuts wood by moving back and forth through it.

**Lag and Lead of Alternating Current**

A direct current flows together in time sense, with the applied pressure or volt-

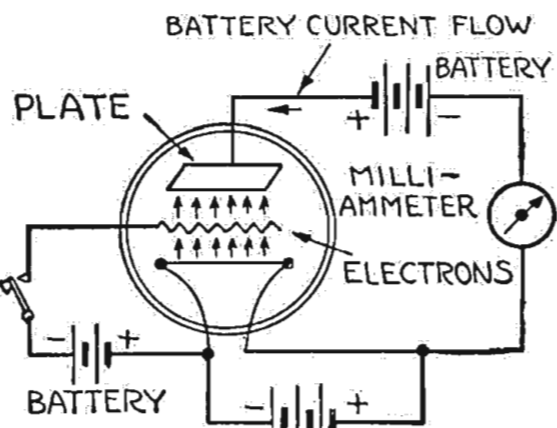

Figure 80.

age. An alternating current can do this in a circuit of pure resistance or when the capacity and inductance are in proper relation. If alternating current is applied to a circuit containing just a condenser,

Figure 76, the current jumps ahead of the voltage owing to the condenser action. If an alternating current is applied to a circuit containing just an inductance coil, the current lags behind the applied voltage because the coil sets up a counter field. If, however, the circuit contains both capacity and inductance, the condenser effect can be made to balance the coil effect so that for a certain frequency the alternating current and the applied voltage act together in time relation. This is called "phase." In tuning Radio sets, a condenser is often combined in certain size with a coil for this effect, which is then called "resonance," i.e. for a certain frequency the condenser effect and coil effect is balanced.

**Electron Flow**

Another form of electron flow is much used in Radio, in vacuum tubes. An ordinary electric lamp with a filament in a vacuum bulb is diagrammed in Figure

Get All Stations with "Eztoon" EASY TUNE RADIO DIALS 3", \$2.00 4", \$2.25

"Eztoon" radio dials make possible that close tuning so essential to bring in stations but a few meters apart. They are large enough to give the slightest adjustment. No friction—they operate as smooth as glass.

Particularly well adapted to Heterodyne, Acmedyne, Neutrodyne and tuned Radio frequency circuits. No holes to drill. Merely take off old dial and slip on "Eztoon."

Sold under positive money-back guarantee

Ask your dealer. If he cannot supply, we will ship parcel post prepaid

Jobbers and Dealers write for discounts

BUTLER MANUFACTURING CO. 3233 W. Washington St. Chicago, Illinois

**BUILD YOUR OWN 5 Tube Neutrodyne Set With Licensed Hazeltine Parts**

**\$39.95 COMPLETE**

**EACH KIT INCLUDES**

- 1—Drilled Engraved Mahoganette Panel... \$ 8.00
- 2-3 Genuine FADA Neutroformers and Condensers... 22.50
- 3-2 Genuine FADA Neutrodons... 2.50
- 4-3 4-inch Mahoganette Dials... 3.60
- 5-20 Feet Tin Copper Bus Bar Wire... .25
- 6-1 Detector Rheostat... 1.25
- 7-1 Amplifier Rheostat... 1.50
- 8-2 Genuine Deitzen Audio Freq. Transformers... 12.00
- 9-5 Vacuum Tube Sockets... 3.95
- 10-2 Frost Neutrodyne Jacks... 1.80
- 11-1 Freshman Grid Leak and Mica Condenser... .65
- 12-1 Dubilier Micadon .001... .40
- 13-1 Mica Condenser .005... .75
- 14-1 Frost Battery Switch... .30
- 15-1 Stained Baseboard... 1.00
- 16-8 Engraved Binding Posts... 1.00
- 17-2 Lengths Black Varnished Tubing... .30
- 18-1 Complete Instruction Book and Blueprints... .50

OUR PRICE... **\$39.95** Regular Price... \$62.25

NETRODYNE has taken the country by storm. It is the remarkable distance getting, powerful, non-oscillating and non-whistling receiver.

WORKING MODEL ON DEMONSTRATION AMERICA'S GREATEST RADIO RETAILERS

**Modell's** ESTABLISHED 1912

\*191 FULTON \*71 CORTLANDT BROOKLYN  
Cor. Church Near Washington \*81 Flatbush Av.  
15 Whitehall St. Post Radio Elec.  
\*14 CHURCH ST. Cor. Stone St.  
Cor. Cortl. \*241 W. 42d St. Corp.  
(\*Open Sat. Ev'gs) Bet. 7th & 8th Aves. (\*\*Open Ev. Ev'g)

MAIL ORDER DEPT.  
58 Church St. NEW YORK CITY

77. Besides emitting light rays and heat, such a filament also shoots off invisible particles of negative electricity called electrons. This occurs much as in the case of water evaporating into steam. In a lamp, however, the electrons shoot off and have no special place to go so after filling up the inside of the bulb and partially leaking back into part of the filament, they form a so-called space charge in the vacuum tube. This is not strange and is comparable to the case of a battery which does not have its plates externally connected through a wire.

(Continued on page 26)

**THE RECEPTRAD SUPER-HETERODYNE MANUAL**

By Lieut. Victor Greiff, E.E., Member I.R.E. Is success insurance in planning any Super-Heterodyne Set. Detailed information with blueprints... **\$1.50**

The Receptrad finest steel cord and shielded Transformer, efficient to the longest wave lengths  
Radio Frequency Type 1716, 5100 to 25,000 meters... \$ 8.50  
Audio Atx & At3, 1st and 2nd stage... 5.75  
S. W. 21 Oscillo-Coupler, 200-750 meters... 6.00  
Tuned Filter Coupler with Condensers 7.50  
Complete kit with engraved panel... 110.00

**Special 5-Tube Neutrodyne Set using Fada Licensed Neutroformers consisting of:**

- 1 7x26 Baseboard.
- 3 Fada Neutroformers.
- 2 Fada Neutrodons.
- 2 Single Bakelite Sockets.
- 1 Triple Bakelite Socket.
- 1 High Ratio Thordarson Tr.
- 1 Low Ratio Thordarson Tr.
- 1 Single Jack.
- 1 Double Jack.
- 1 Cut-out Switch.
- 1 Fada Power Rheostat.
- 1 Fada Six-ohm Rheostat.
- 1 7x26 Mahogany Panel engraved in gold lettering.
- 3 Mahogany Dials.
- 1 .00025 Grid Condenser.
- 2 Megohm Leak.
- 2 .006 Condensers.
- 8 Initialed B. P.
- 1 .002 Condenser.
- 1 Fada Booklet.

Bus, wire, spaghetti, screws.

1 Mahogany finish Cabinet. BUILT FOR YOU FREE.

**Special \$68**

D. C. Charger with meter... **\$10.00**

Charge your own batteries. Send for Price List

**E. SINGER CO.**

187 Greenwich Street New York City

**'Nightingale'**

4-TUBE RADIO SET

**\$32.50**

Without Accessories

HANSEN BIRD-CAGE LINE

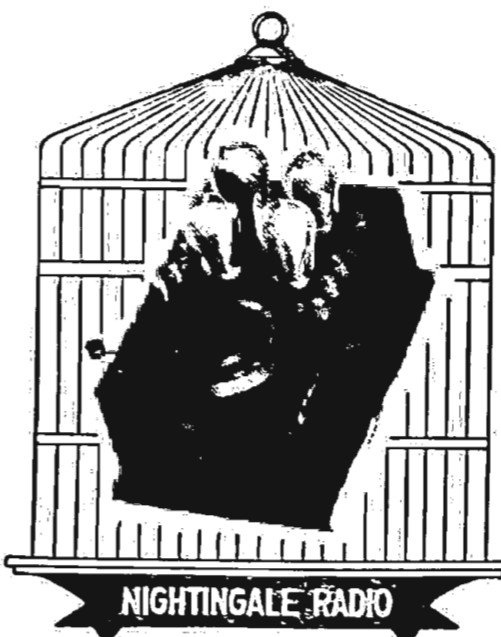

Here's the Radio Set that we will back up to the last stitch. It's simply wonderful and wonderfully simple. The FORD OF RADIO and then some.

2000 Miles Range That Can Be Proved  
MOCKING BIRD... **\$ 90.00**  
MEADOW LARK... **180.00**

Let us send you our literature

DEALERS A wonderfully attractive proposition JOBBERS We want one responsible and active distributor in each state

National Distributor

**HANSEN STORAGE CO.**  
134 Jefferson Street MILWAUKEE

**3/4 Actual Size**

**HEGEHOG** \$3.50

Ideal for Portable Sets  
**PREMIER Audio-Frequency TRANSFORMER**

Because it is the smallest, lightest, and yet unsurpassed in efficiency, the Hegehog is just the thing for use in portable sets where space saving, compactness, and light weight are of real importance. You take no chance with "Hegehog." It's a real engineering job, exclusively Premier, patents pending. A demonstrated wonder for volume, tone quality, and consistent performance. Unconditionally guaranteed. Try "Hegehog" in your next "hook-up"—portable—regular sets. Give it every possible test. If you are not satisfied in every way, you can have your money back. We know the "Hegehog" and we want you to know it. Ratios 1 to 3, 1 to 4, 1 to 5—\$3.50. 1 to 10, \$4.50. Send for Free Bulletin No. 92. Ask your dealer for "HEGEHOG"

**Premier Electric Company**  
3810 Ravenswood Avenue CHICAGO

Highest Quality **CORBETT'S CABINETS** All Styles

Style D—Hinged top, hinged back, grooved front and 5-inch battery compartment.

Style C—Hinged to base.

Size	Gen-uine Oak Mahogany & finish	Solid Walnut Mahogany & finish	Size	Gen-uine Oak Mahogany & finish	Solid Walnut Mahogany & finish
7x10-7	\$4.00	\$6.00	7x28-8	\$ 7.00	\$10.50
7x12-8	4.24	6.36	7x30-8	7.65	11.50
7x14-8	4.47	6.70	7x36-8	8.95	13.40
7x18-8	5.06	7.60	7x40-8	10.12	15.18
7x21-8	5.53	8.30	7x27-9	7.18	10.75
7x24-8	6.00	9.00	8x40-8	11.70	17.55
7x26-8	6.35	9.53	8x26-8	7.20	10.80

Style A, grooved front, Style B, rabbeted front, and Style C, hinged to base, take above prices. Style D, add 75%, and Style E, hinged to base with 5-inch battery compartment, add 100%. 14d stays 20c extra, panel brackets as illustrated 15c per pair extra, piano hinges 5c per inch extra, baseboards 8% extra.

Finely molded top and base. Varnished finish carefully hand rubbed. Accurately made and well packed. Shipping charges prepaid to Mississippi, and balance beyond collect express.

DEALERS—Our cabinets will sell over the counter. Boatlet free. Special cabinets and furniture to order at reasonable prices.

Terms—Cash, with order

**Corbett Cabinet Mfg. Company**  
1415 East St. Factory  
Pittsburgh, Pa. St. Marys, Pa.



# Old Stand-by Short Wave Regenerative Hook-Up

## Part I—Layout of Parts and Panel

By Major R. C. Schoonhoven

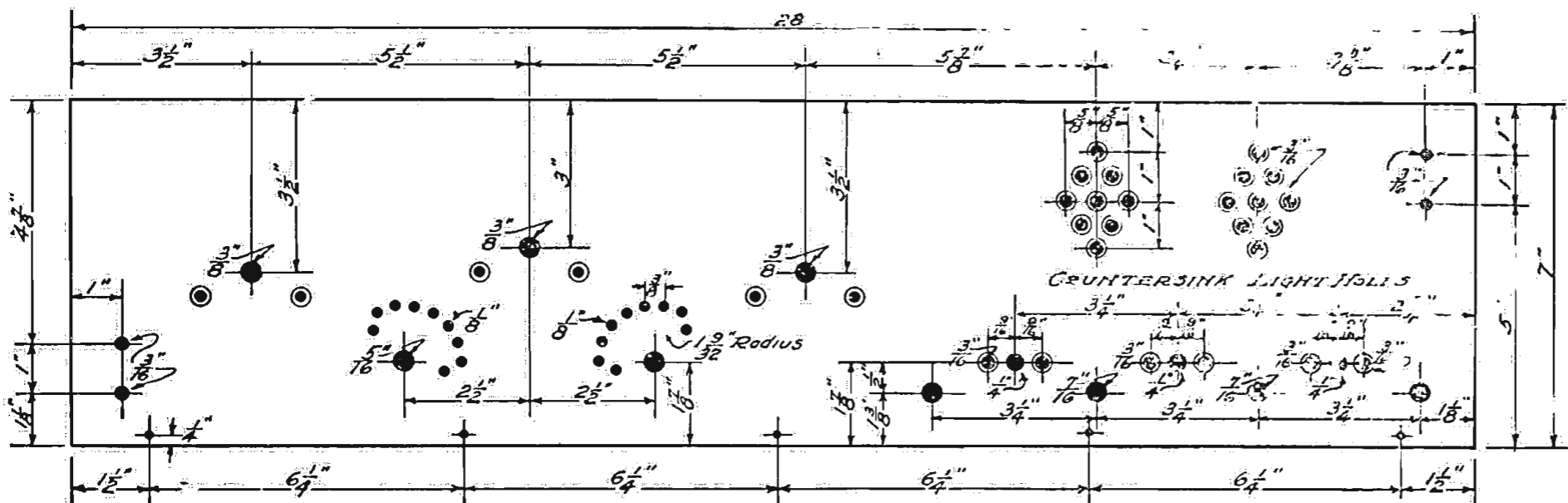

**T**HE short wave regenerative receiver which I am about to describe has given excellent results for many years and can be classed as one of our old standby circuits. Many circuits have been tried using similar parts, but for all-around results the Radiophan will find that he can depend on this hook-up.

The circuit drawing can be followed in wiring the set, and as each part is named and lettered you should have no trouble in following the hook-up.

The front elevation gives the reader an idea of the layout of the parts as placed on the panel and plan of the location of the parts as spaced on the mounting board.

### The Panel Layout

The panel layout gives all the measurements necessary to locate the parts, but

the variometers, variocoupler and rheostats are drilled larger than necessary so as to allow for any inaccuracy in the placement of these units and to prevent the binding of the shafts. You will also notice that the distance of the holes used to support the variometers and variocoupler are not given, as no two variometers or variocouplers are held in place by the same method.

### Holes for Inductance Switch

The number of holes drilled for the inductance switch will vary according to the number of taps on the tube or primary of the variocoupler. These holes are spaced 3/8-inch from center to center for the average switch points on the radius called for by the inductance switch you plan to use.

After all holes are drilled it is neces-

sary to countersink the holes that support the variometers, variocoupler and rheostats, and I suggest you also countersink the light holes to remove the sharp or rough edge. You can now give the panel a dull finish by using fine sandpaper or steel wool with a little oil, always rubbing in the same direction. This will remove all the rough edges caused in drilling and will give the panel a much neater appearance.

### Wiring the Set

After placing the panel on the mounting board the parts can be put in place by following the plan showing the location of the parts. After this has been finished the set will be ready to start wiring. I prefer number 12 or 14 tinned copper wire, which can be plain or insulated.

The antenna and ground goes direct to the inductance switches and the switch points are connected to the tube or primary of the variocoupler. If only one set of taps are used on your variocoupler the antenna can be connected to the end of the primary winding and the taps connected to the ground lead through the switch points and inductance switch. In this case only one switch will be required in place of two called for on the list of parts.

A .0005 capacity variable condenser is shown in dotted line shunted between the ground and antenna and another of .00025 capacity across the secondary of the variocoupler. As these two condensers are not required for good results, but only used to raise the wave length of the set, I did

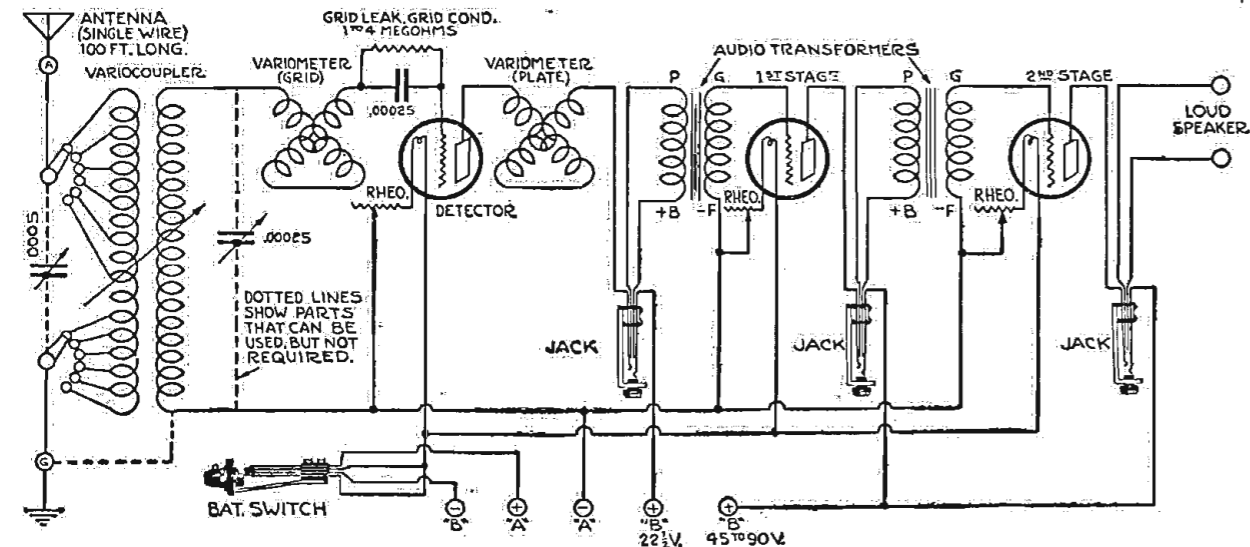

before drilling the panel make sure the parts you have on hand, or the ones you purchase, are satisfactory; if not, change the measurements accordingly. I find that it pays in a large number of cases to lay the panel out on heavy paper or cardboard before starting to drill the holes, as this might save you considerable trouble and maybe a panel. The paper can then be placed on the panel and all holes centered by the use of a center punch. I find that you can always do much neater work by drilling a small hole as a center and then finish by drilling the proper size hole.

The center holes used for the shafts of

not provide a space for them on the panel, so, if wanted, table type connectors can be used.

(TO BE CONTINUED)

### Crystal Mounting

In the illustration is shown a setting and operating lever for a crystal set. The adjusting device consists of a U-shaped piece mounted on a base carrying a pointed adjusting screw. A binding post is used to hold the crystal, the base of which is soldered, at 2 in a slot cut in it, as at 3. The cat whisker is held in the hole 4. The binding post for the output has a metal strip, 5, at the

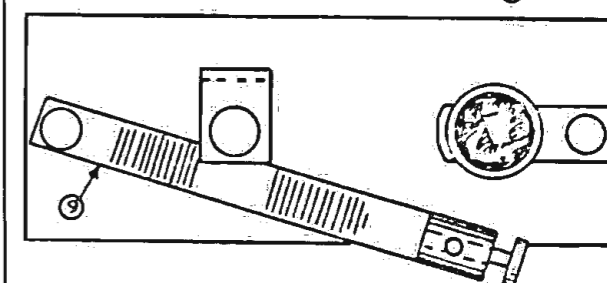
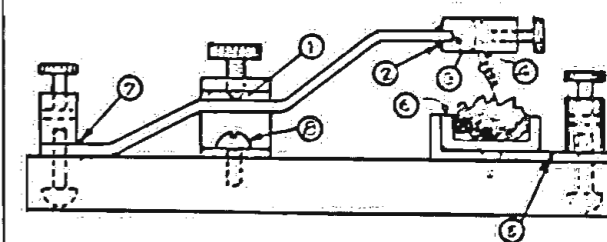

base to hold the mounting, 6, for the crystal. The input binding post holds the lever at 7. The screw 8 holds the adjusting clip. The lever 9 can be turned to one side as shown.—Arthur Rettman, Pittsburgh, Pa.

### S. O. S.

The call "S. O. S.," used by ships at sea as a distress call, is purely arbitrary in its grouping of letters, and was chosen because of the unusual combination of dots and dashes, which make it distinctive above all other calls. It consists of three dots, space, three dashes, space, and three more dots.

**USE-IS THE TEST**

## THORDARSON

### POWER AMPLIFYING TRANSFORMERS

Price per pair, \$13.00

The new Thordarson Power Amplifying Transformers (push pull) are designed for use as third stage audio frequency amplifiers, to provide high power amplification for operating loud speaking devices.

With power amplification, not only is it possible to increase volume, but, since two tubes replace the usual one, the distortion and howling which usually accompany the overloading of a single tube on the third stage is done away with entirely.

The Thordarson Power Amplifying Transformers are well constructed electrically and are capable of indefinitely carrying the additional load without breaking down.

In tonal purity these transformers equal the Thordarson Super Audio Frequency transformer whose rich quality and even amplification has made it the popular transformer of the day.

## THORDARSON

ELECT. MFG. CO.  
500 W. Huron St. CHICAGO

**Build Your Radio Set With Kellogg Guaranteed Parts**

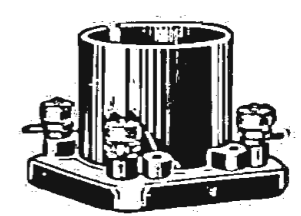

**KELLOGG** Tube Sockets are of heavy moulded Bakelite and fit all standard four prong base vacuum tubes for radio work. The four springs are of spring-tempered German silver of unusual resiliency, making positive contact with the tube terminals. The springs are firmly held in deep grooves and cannot touch the mounting surface. The notch taking the tube stud is reinforced with a brass plate eliminating possibility of breakage at this point. Terminals are clearly marked.

A sturdy foundation for your radio tubes.

Specify Kellogg radio equipment and know you are getting the best.

If your dealer does not handle Kellogg communicate direct with us.

**Kellogg Switchboard & Supply Company**  
1066 W. Adams • CHICAGO

**USE-IS THE TEST**  
**KELLOGG**

## ARROW BATTERY

### SLASHES Prices TO CONSUMERS

Prices Smashed! Quality Not Sacrificed

Here is real battery quality, guaranteed to you, at prices that will astound the entire battery-buying public. Order direct from factory. Put the Dealer's Profit in your own pocket. You actually save much more than half, and so that you can be convinced of true quality and performance, we give a **Written Two-Year Guarantee**

Here is your protection! No need to take a chance. Our battery is right—and the price is the lowest ever made. Convince yourself. Read the prices!

- Special 2-Volt Radio Storage Battery, \$3.75
- Special 4-Volt Radio Storage Battery, 6.00
- 6-Volt, 60 Amp. Radio Storage Battery, 7.00
- 6-Volt, 80 Amp. Radio Storage Battery, 8.00
- 6-Volt, 100 Amp. Radio Storage Battery, 9.50
- 6-Volt, 120 Amp. Radio Storage Battery, 11.50
- 6-Volt, 140 Amp. Radio Storage Battery, 13.00

We ask for no deposit. Simply send name and address and style wanted. Battery will be shipped the day we receive your order Express C. O. D., subject to your examination on arrival. Our guarantee accompanies each battery. We allow 5% discount for cash in full with order. You cannot lose! Act quick. Send your order today—NOW.

**Arrow Battery Co.**  
1421 South Wabash Ave.  
Dept. 5 Chicago, Ill.

Try the NEW

## Pfanstiehl

### VARIOMETER P 301

in the Hagerman Universal hook-up

This Variometer (connected so as to buck) is a bear-cat for selectivity—

Price \$4.75

Postpaid or at your dealers

Pfanstiehl Book of Hook-ups Free with Order

**Pfanstiehl Radio Service Co.**  
Highland Park, Ill.  
Chicago: 1001 W. Washington St.  
PHONE: HAYMARKET 8010



### THIRTY MINUTE A-B-C

(Continued from page 24)

When, however, a metal plate is put inside the vacuum tube, the electrons can flow to it. If an external circuit is connected and supplied with local battery so

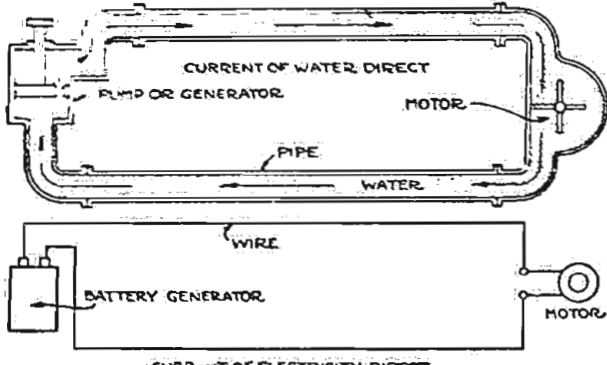

Figure 81.

that the plate gets a positive charge, a large number of electrons can flow to the plate. The local battery can then send a current through the space between the plate and the filament.

Figure 80 illustrates the relations in a vacuum tube. The filament is heated and emits electrons which can pass to the positively charged plate. The plate battery can then send a current through the

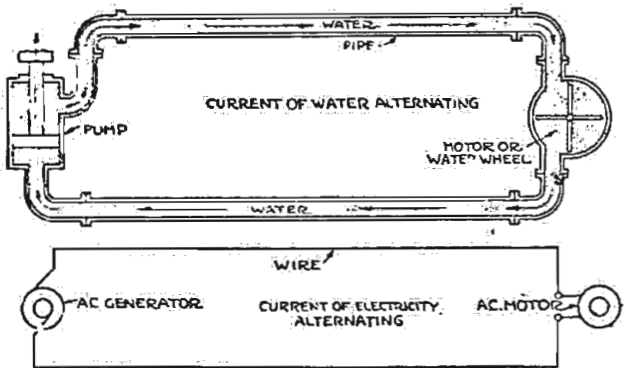

Figure 82.

electron flow, this current going between the plate and filament and coming from the battery. A third piece of metal called a grid can be used to regulate the electron flow and thus govern the plate battery flow. Should the grid have no charge, it has no effect. If positively charged it acts like a plate and lets current flow from grid to filament. If negatively charged

it opposes the negative electron flow, and can even be negatively charged enough to stop this flow. Then no plate current could flow from the plate circuit battery.

Figure 81 should assist in fixing direct current flow in mind by analogy to the water flow shown. A corresponding diagram for alternating current is shown in Figure 82.

#### Why Alternating Current Passes a Condenser

From Figure 83 it will be seen that a rubber diaphragm is inserted in the water pipe, representing a condenser in the wire circuit. A direct water flow could only stretch this diaphragm in one direction and then the flow would stop so the paddle wheel motor would not run. But an alternating motion on the pump diaphragm (generator supply) will send the water rushing one way, then reversely, and can move

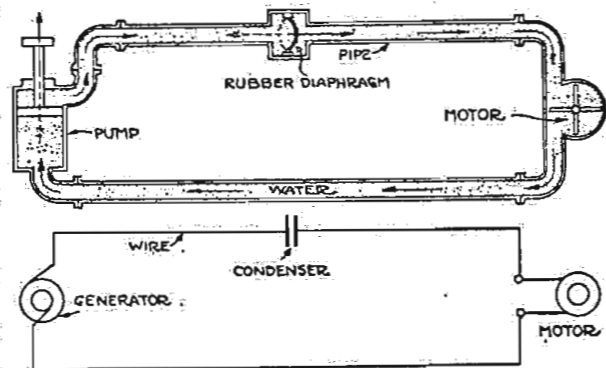

Figure 83.

the paddle wheel. In electric power work suitable construction in the motor changes the alternating power source into continuous direction motion.

#### Rectifiers

There are other devices which can change an alternating current effect into an equivalent direct current result. Such devices are called rectifiers. In Radio a detector acts as a rectifier to let the Radio current change into direct current flow.

Radio diagrams will next be taken up in this series.

(TO BE CONTINUED.)

When winding a loose coupler, both coils must be wound in the same direction in order to obtain the best results.

### The Reader's View

#### Reception In a Well

I have been doing some experimenting with receiving sets, so recently I decided to make use of an old well which has been dry for several years. It is 70 feet deep and 4 feet wide. After fixing up a windlass with the help of two neighbors, I descended in the well with a lot of encouragement from the neighbors and a detector set under my arm, and it was right there that I was called a Radio nut and a lot of other things. Well, after reaching the bottom of the well, the boys let the aerial down to me which was of number 14 seven-strand wire, and I proceeded to hook up the set, a single-circuit using a WD-11 tube and one dry-cell battery, and it oscillated like a top. This took place about 4:30 p. m. and after a lot of tuning and a lot of "come up out of there" and several other threats from the boys up above, I decided to let it go until 8:00 p. m., at which time most stations would be broadcasting. So, at eight I went down again and with a twist of the dials in comes WJAZ like a house afire. Here I was 500 miles from the Crystal studio and 70 feet down in a well and the boys above lying on their stomachs listening to a jazz orchestra through a pair of Baldwin receivers.

How is that for distance? Who can beat it?—Ray P. Murphy, Sioux City, Ia.

#### Holding Solder on Iron

Radio set builders and experimenters who have trouble with their soldering irons will find 10 cents worth of sal ammoniac a good investment. It is a white powder. When the iron gets refractory about holding solder file it clean and bright, heat it a trifle above soldering temperature. Plunge it in a solution of sal ammoniac and apply solder and rosin, or use rosin cored solder. Coat the point half way up the iron. Let the iron cool and then use it as before. Care in not getting it too hot will prevent burning off the "tinning," as it is called.

9 1 1/2% of all tubes are Needlessly Destroyed

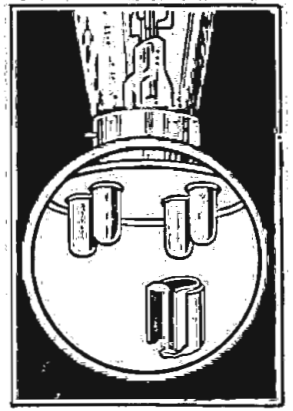

RADECO SAFETY FUSES

GIVE COMPLETE PROTECTION Price 50 cts. each

Dealers write for proposition.

Radio Equipment Company 20 Stuart Street BOSTON, MASS.

### Workman Radio Service

14-16 Vesey St. NEW YORK

- VARIOCOUPERS**
  - \$3.50 Workrite 180° Silk Wound.....\$2.95
  - 3.50 Fisher, Large, 90°..... 2.75
  - 2.75 Fisher, 180°..... 2.25
  - 4.25 Special Bank Wound Coupler for Haynes Circuit (with diagram)..... 3.25
  - 7.00 Ambassador Coil (with diagram)..... 5.50
- VARIOMETERS**
  - \$3.50 Workrite.....\$2.95
  - 5.00 Pathé Moulded..... 2.25
  - 3.50 Fisher, Large..... 2.85
- CONDENSERS**
  - \$2.00 R. C. 11 plate.....\$1.05
  - 2.35 R. C. 23 plate..... 1.35
  - 2.75 R. C. 43 plate..... 1.65
- VERNIER CONDENSERS**
  - \$4.00 R. C. 23 plate.....\$2.25
  - 5.00 R. C. 43 plate..... 2.95
- PHONES**
  - \$18.00 DR. SEIBT IMPORTED "SUPER \$6.90 HEADSET".....\$6.90
  - \$12.00 N. & K. Imported.....\$6.90

The above items are just a few of our numerous attractive priced articles, which are contained in our BULLETIN OF RADIO PARTS. Gladly sent to you upon request.

We specialize in the FAMOUS AMBASSADOR LONG DISTANCE CIRCUIT. Write for list of parts for this set. Either single or three tube set. Price of parts for single tube set.....\$15.50 Price of parts for THREE TUBE SET.....28.90 We are headquarters for "Radion" and "Bakelite Dilecto" Panels. The best panel material available. Mail orders promptly attended to. All orders amounting to \$5.00 or more will be shipped prepaid. Will ship C. O. D. unless remittance accompanies order.

### Bradleyswitch PERFECT BATTERY SWITCH

Sold by leading Radio Dealers and Jobbers

Nickel plated locknut and polished knob

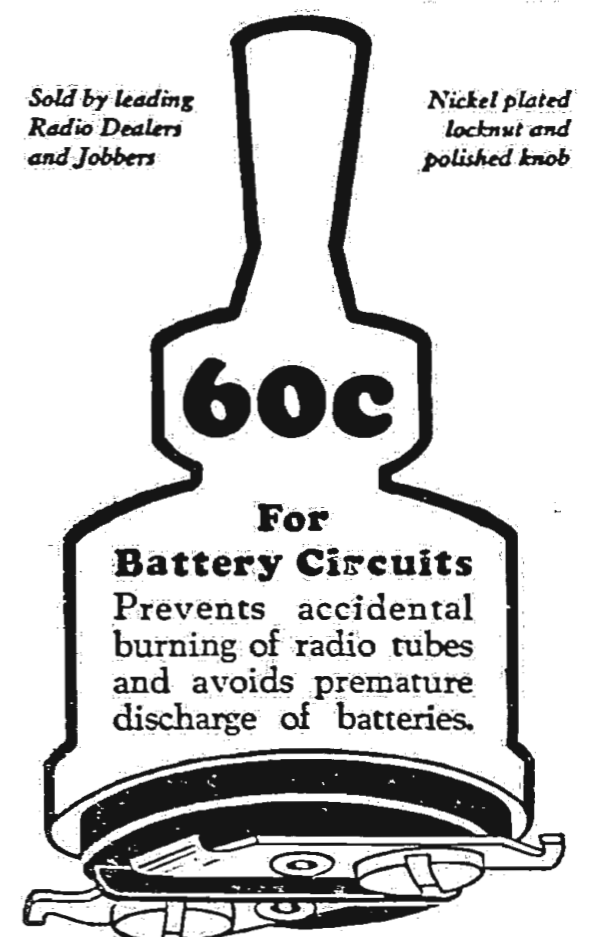

Improves Your Radio Set Drill only one hole in your radio panel to install the Bradleyswitch. Nickel plated knurled nut holds it securely in place. Totally enclosed and dustproof.

ALLEN-BRADLEY CO. 290 Greenfield Ave. Milwaukee, Wis. Manufacturers of the Universal Bradleyswitch

## Dubilier Duratran

reduced from \$5.00 to \$4

Increased production has lowered manufacturing costs of the Dubilier Duratran—the radio-frequency transformer that brings in all the stations loud and strong—not just a few. And you receive the benefit in a big price reduction.

At all good dealers. DUBILIER CONDENSER & RADIO CORPORATION 42 West Fourth Street, New York

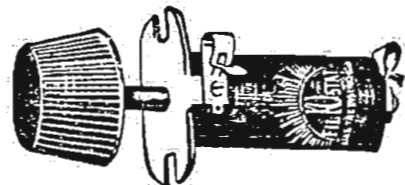

### GET DX YOU ARE MISSING

Your set is probably bringing in DX stations you never hear because your rheostat cannot control your filament action. The FIL-KO-STAT gives infinite adjustment and enables you to magnify weak stations and bring them in strong and clear. Write for

Improved Radio Reception Through Scientific Tube Tuning

This new FREE DX radio book tells: How to stop reradiation. How to control regeneration. How to tune your tube as well as your hook-up, etc. Published by

DX INSTRUMENT CO., HARRISBURG, PA. Who make and guarantee

## FIL-KO-STAT

The Scientifically Correct Radio Rheostat Sole International Distributors RADIO STORES CORPORATION 318 West 34th St. New York

### HERE IT IS Burns LOUD SPEAKER

For Phonograph or with horn

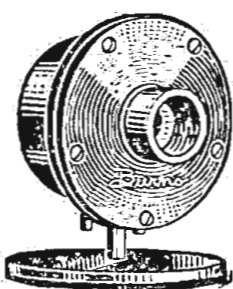

Tone can be adjusted to suit any plate voltage. Pleasing tone, loud and clear. No extra batteries required.

- UNIT with connector for any make of phonograph.....\$10.00
- SPEAKER complete with non-vibrating horn.....\$20.00

Manufactured by American Electric COMPANY State and 64th Streets CHICAGO

### Campbell RADIO CABINETS

"From the Lumber to You"

PRICES—Cash with order, prepaid east of Missouri River; west, add 15 cents to quoted price. Send Post Office or Express Money Order.

Panel Sizes	Imitation Walnut or Mahogany	Genuine Walnut or Mahogany
7x10x7	\$3.54	\$ 6.28
7x14x7	3.84	7.12
7x18x7	4.24	7.30
7x21x7	6.52	11.48
7x26x7	8.78	14.50
7x28x7	9.00	15.50
7x26x8	8.84	13.18
7x28x8	9.14	13.84

Special Sizes to Order

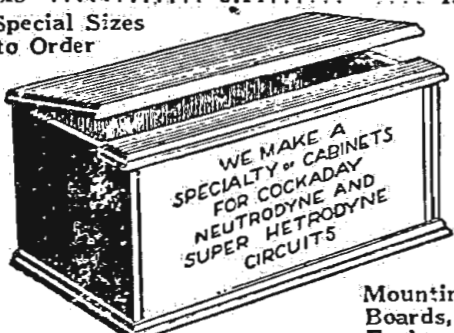

Mounting Boards, 50c Each

Will not warp or crack. Made of No. 1 wood finished in either Mahogany or Walnut, bright or rubbed finish.

Manufacturers' and Dealers' Inquiries Solicited THE PERKINS & CAMPBELL CO. (Established 1879) 410-440 New Street, CINCINNATI, O. (References: Dun or Bradstreet's)

### Dealers Need This

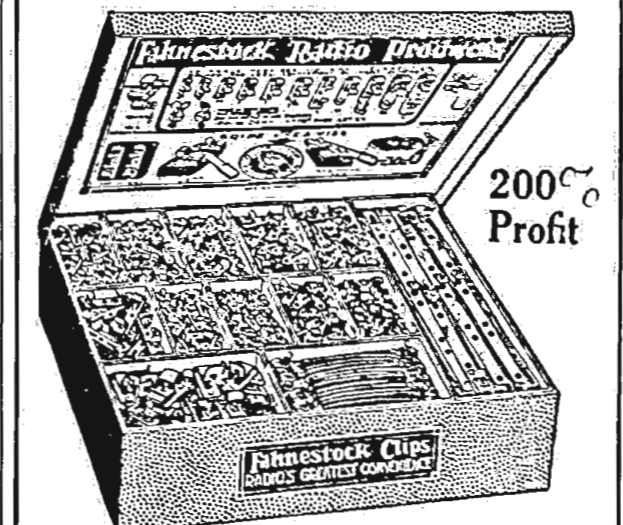

The new FAHNESTOCK Display Case Will stimulate your sales of Fahnestock Radio Products. 14 of the most popular styles and sizes are included. Shows the purchaser instantly the correct piece for his set. A constant invitation to buy Fahnestock Products. Dealers are offered 200% profit on each case, an unusual offer on standard merchandise.

- Price to Dealer.....\$17.50
  - West of Mississippi..... 18.50
  - Transportation prepaid when money order or check accompanies order. Subsequent orders at regular price of \$20.00.
  - Contents Retail for \$51.50
- Refills will be supplied at the regular 100 lot prices, shown in catalogue, which comes with case, less discount shown on enclosed sheet. Send check or money order, today.
- FAHNESTOCK ELEC. CO. LONG ISLAND CITY NEW YORK



# New Homemade Spider Web Mounting

## Primary Coil Is Tapped for Selective Tuning

The coil control described in this article takes the place of three honeycomb coils and it gives many advantages over these coils. The coils are mounted back of

### COILS ARE BACK OF PANEL

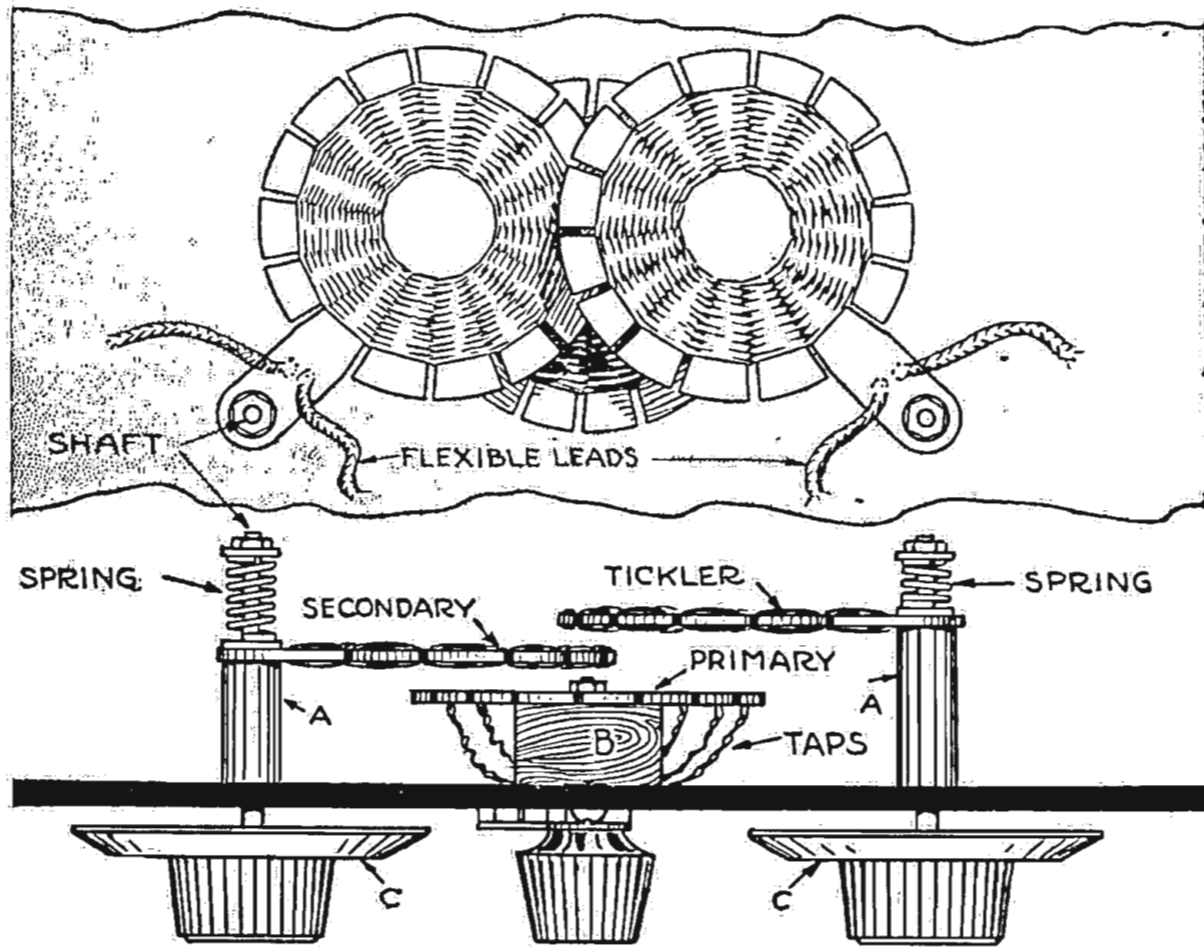

### Mast Fastening

To mount a mast for an aerial on top of a house or building with an A-roof, take a 2 by 2 or a 2 by 4 stick of the

will depend on the size of the stick to be used). Mount the stick astraddle the ridge boards, nail or screw the other end of the hinge to the roof, and you have a very neat looking substantial job. Properly guyed, this mast will stand all the strain that will ordinarily come on it.

I am using a 2 by 2 stick, 8 feet long, with only one guy wire, and it has withstood several heavy storms. I fell on this idea by chance. Was trying to figure out some way to mount the mast so it would be solid and still look decent when I stepped on an old rusty hinge lying in the dirt, and this idea flashed into my mind.—U. G. Tuttle, Denver, Colo.

## WORKSHOP KINKS? EARN A DOLLAR—

**T**HERE are many little kinks worked out at home that would aid your fellow Radio worker if only he knew about them. There are new hook-ups, new ways of making parts and various unique ways of operating sets that are discovered every day. Radio Digest is very much interested in obtaining such material. Send them in with full details, including stamped envelope, so rejected copy may be returned. The work must be entirely original, not copied. RADIO KINKS DEPARTMENT, Radio Digest, 123 W. Madison St., Chicago

the panel, thus improving the appearance of the set and protecting the coils from dust. The primary coil may be easily tapped for fine tuning, and the panel in front of the coils is shielded with a piece of tinfoil, thus reducing capacity effects.

The coils are similar to spider web coils in construction, and the form for winding the coils is the same except for one of the winding legs which is made longer for connection to the shaft, as shown. All arms on the primary or stationary coil

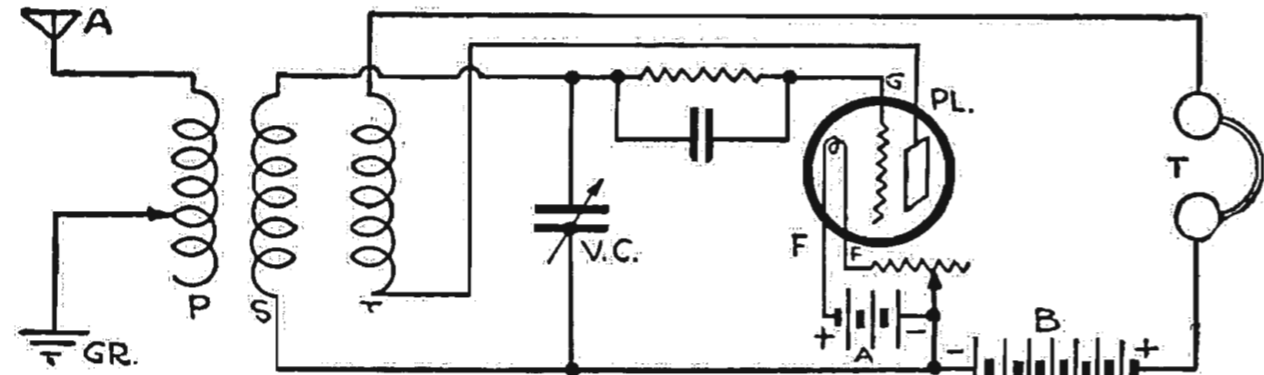

are the same length, and the coil is fastened to the panel with a small block B, and a bolt as shown. This stationary coil may be very easily tapped, the leads being led to contact points on the panel. A threaded shaft is required for each movable coil, this being fastened to the coil form with two nuts. A section of brass tubing A, is cut and used to space the coils and keep them from touching. A spring, together with the necessary washers and nuts, keep the shaft with the coil mounting pressed against these pieces of tubing. A dial C is fastened onto the other end of each shaft to turn the coils to and away from the others. The coils are arranged in order as is clearly shown in the illustration. They are wound with the proper number turns of wire, about 60 for the primary, from 40 to 90 or more for the secondary, and from 40 to 120 for the tickler, the number of turns being in accordance to the manner in which the coils are to be used.

Two of the coils may be used as a variocoupler, or three as with honeycomb coils. A preferred hook-up for using three coils is given.—Evermont Fisel, Junction, Ky.

Rubber tape is better than friction tape for aerial work.

desired length and saw a V-shaped notch in one end, of a size to fit over the boards on the comb of the roof; then fasten a

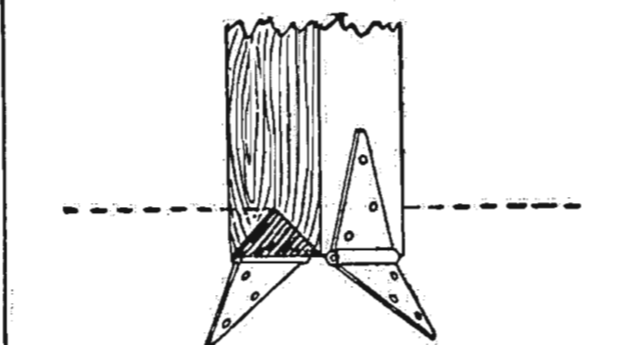

common strap hinge to each side of the stick with screws, as shown (a 6 or 8-inch hinge will be about right, but size

## SUPER-HETERODYNE

PARTS \$71.50

SEND FOR PRICE LIST

SETS MADE TO ORDER

FORBES RADIO CO.

127 North Dearborn Street, Chicago, Illinois

*Compare*

The new

## CARTER

Vernier Control Rheostat

Part for part—and note the advanced original design.

Mounts in one hole.  
Pig tail connection.  
Smooth running.  
Satin finish.  
Any dealer can supply.

**Carter Radio Co.**  
205 S. STATE STREET  
CHICAGO

USE THIS EARLY! DON'T MISS IT!

**WHERE I GO BY RADIO**

Special Limited Offer only 25 cents

To close out quickly the small remainder of our second large Popular Edition of

## "Where I Go By Radio"

The Popular Radio Record Book with the Easy, Complete Record System, and make way for the Enlarged, Improved Edition to be issued soon, we will sell, while present stock lasts, our

POPULAR EDITION FOR ONLY 25 CENTS when four copies are ordered at one time sent to one address.

Book also contains List of Broadcasting Stations, How to Measure Distances, and other useful features. Order at once. Give your friend a copy. You'll get a hearty "Thank You."

**RADIO BOOK DEPT., PROGRESS PRESS**  
UNION, SOUTH CAROLINA

## Vernier Attachment to A Plunger Grid Leak

A vernier adjustment may be applied to the plunger type of grid leak, as shown in the illustration. The plunger type leak is mounted so that it may be adjusted by the turning of a screw which is mounted through the panel.

An L-shaped piece of hard rubber 5 inches long on one part and 3 inches long on the other is cut from an old battery jar and the grid leak is mounted between two copper or brass strips on the 5-inch end and is held with two brass screws.

Wiring connections to the coil and tube socket is made from the two screws. The adjusting screw is mounted on the 3-inch end so that it will press against the plunger of the grid leak which is pulled out to its full length. The adjusting screw has two nuts, one on each side of the rubber mounting piece. Two pieces of hard rubber are fastened under the two nuts on the adjusting screw, one being on each

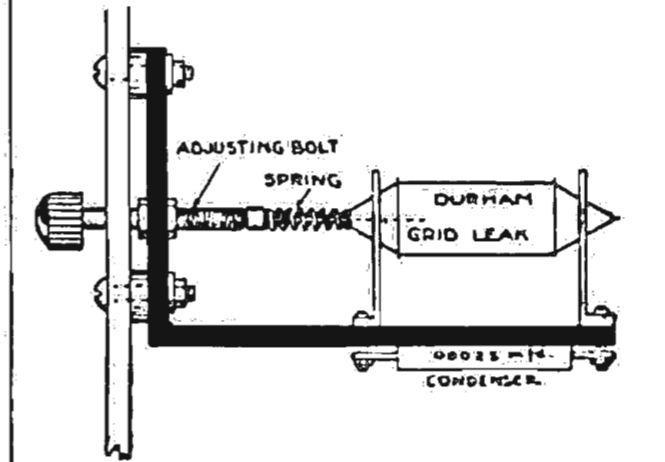

to stop and hold the nuts from turning with the screw.

A small coil spring is made from fine spring wire and placed on the plunger to keep it against the end of the screw.—Chas. J. Curran, El Paso, Tex.

Porcelain is one of the best insulators for the aerial, but there are good and bad grades.

Price 50 cents everywhere

Never sold at cut prices

**B-METAL**

Loud Talking Crystal

Sold only by reliable dealers and at full price. The Premier Crystal of the Radio World today. Ideal for REFLEX or CRYSTAL sets. Order, if possible, from your dealer. If he does not have it, send to us for one. Price, 50 cents postpaid.

New Jobbers and Distributors Plan Now Ready

**B-METAL REFINING COMPANY**  
525 Woodward Avenue, Suite 48  
DETROIT, MICH.

**GENUINE B-METAL**

Chicago Branch 53 West Jackson Street  
New York Branch 212 Fulton Street

## 514-Page RADIO Handbook Only \$1

Just off the press. The greatest book on Radio ever written. 514 pages. Compiled by Harry F. Dart, E.E., formerly with the Western Electric Co., and U. S. Army Instructor of Radio. Technically edited by F. H. Doane. Filled with sound, practical, tested information for every radio fan, from beginner to hard-boiled owl. Send \$1 to-day, and get this 514-page I. C. S. Radio Handbook before you spend another cent on parts. Money back if not satisfied. 40,000 already sold.

Mail the Coupon To-day

International Correspondence Schools  
Box 8277-H, Scranton, Penna.

I enclose One Dollar. Please send me—post-paid—the 514-page I. C. S. Radio Handbook. It is understood that if I am not entirely satisfied I may return this book within five days and you will refund my money.

Name.....  
Address.....

**WE REPAIR THE FOLLOWING RADIO TUBES**

Dealers and Agents write for Special Discount  
Mail Orders Solicited and Promptly Attended to

WD-11, WD-12, Our Specialties

WD-11	.....\$3.00	DV-6A	.....\$3.00
WD-12	.....3.00	UV-199	.....3.00
UV-200	.....2.75	C-299	.....3.00
UV-201	.....3.00	UV-201A	.....3.00
C-300	.....2.75	C-301A	.....3.00
C-301	.....3.00	Marconi	.....3.00
DV-6	.....3.00	Moorhead	.....3.00
DV-1	.....3.00	6 V. Plain Det.	2.75
DV-2	.....3.00	6 V. Plain Amp.	3.00

**H. & H. RADIO COMPANY**  
P. O. Box 22-A  
Clinton Hill Station NEWARK, N. J.

# Duo-Reflex

Tube for Tube—the Most Powerful Circuits Ever Built. Write for free Bulletin No.16

Electrical Research Laboratories  
CHICAGO.  
E.R.L.



### LONG DISTANCE RECEPTION ON SINGLE TUBE

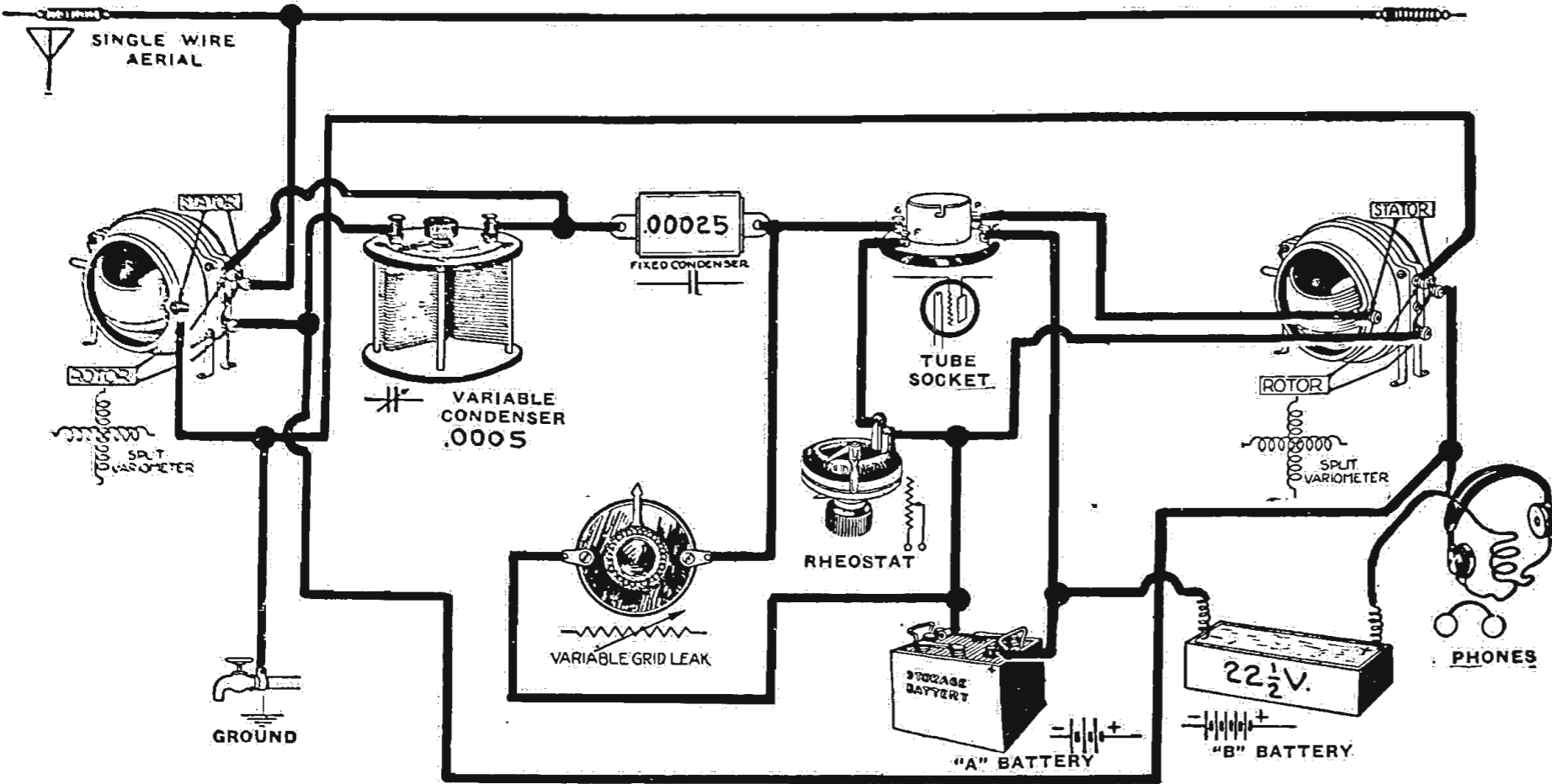

**S**PLIT variometers have a habit of getting mixed up with long distance work. Do you know why? Well, inductance tuning means dead end losses, while capacity tuning, when good variable condensers are used, undoubtedly gives real satisfaction for long distance results. Do you know that the neutrodyne is a

capacitively tuned circuit? Hence the results. Think it over. This circuit uses two split variometers and a good .0005 variable condenser (not the 75-cent kind). Yes, and a good variable grid leak will help things a lot. The rest of the parts are the usual collection of necessities. Get a good aerial,

100 feet, including lead-in; a good ground connection, plus a good detector tube, and give it a fair chance. Then watch it give you some real results. But get used to the tuning, before you try to get 2LO; you know so many want to get long distance work before they get acquainted with their sets.

### ADVANCE PROGRAMS

(Continued from page 18)

#### Tuesday, May 6

**KFSG, Los Angeles, Calif.** (Pacific, 278), 2:30-4:30 p. m., Sacred Divine Healing Services conducted by Aimee Semple McPherson; 6:30-7:00, Children's Hour; Bible stories by Mrs. M. Kennedy; 8:00-8:25, Special feature program; 8:25-9:15, Revival Sermon and Altar Call by Aimee Semple McPherson; 9:15-10:00, Popular program of sacred songs presented by the Negro Swanee Jubilee Singers under direction of John Hall; 10:02-10:10, The Family Altar and Prayer conducted by Aimee Semple McPherson. The Angelus Temple Chimes will sign off KFSG.

**KFI, Los Angeles, Calif.** (Pacific, 469), 6:45-7:30 p. m., Concert selections; 8:00-9:00, Ambassador-Max Fischer Coconut Grove Orchestra; 9:00-10:00, Examiner concert; 10:00-11:00, Concert.

**KGO, Oakland, Calif.** (Pacific, 312), 8:00 p. m., Mazda Banjo Quartette; Gwynn Jones, tenor; Muriel Clair Moorehead, pianist; Vera Frances Morse, reader; Maude Goodwin Ivanhoe, soprano; Toffer's Hawaiian Trio. Address, "Editorial Arrows," Charles K. Field; Monologue, "On the Train," Irene Barrie; Readings, "Grandmother's Garden," "When Ma Lost Her Pocketbook," Vera Frances Morse.

**KCW, Portland, Ore.** (Pacific, 492), 12:30 p. m., Concert, Civic Music Club; 3:30, Talk, Jeanette P. Cramer; 7:45, Talk for farmers, Oregon Agricultural College Extension Service.

**KHJ, Los Angeles, Calif.** (Pacific, 395), 12:30-1:15 p. m., Concert; 2:30-3:30, Matinee Musicale; 6:00-6:30, Art Hickman's Concert Orchestra; 6:30-7:30, Children's program, "Stories of American History," Prof. Walter Sylvester Hertzog; Weekly visit of the Sandman and Queen Titania; Bedtime story, "Uncle John"; 8:00-10:00, De Luxe program; 10:00-11:00, Art Hickman's Dance Orchestra.

**WAAM, Newark, N. J.** (Eastern, Daylight Saving, 255), 7:00-7:30 p. m., "Star Spangled Banner"; Edw. A. Sussman's Original Memphis Syncopators; 7:30-7:45, Jimmy Clark's Broadway Melody Entertainers; 7:45-8:00, Keboe Sisters and Theophylus Alban; 8:00-8:15, Anter Male Quartette; 8:15-8:30, Arundel Cotter of Wall St. Journal, talking on C. W. Barron; 8:30-8:45, Brandorff String Quartette; 8:45-9:00, Chas. D. Goldfarb, baritone; 9:00-9:30, Edw. A. Sussman's Original Memphis Syncopators; 9:30-9:45, Shella Kemble, soprano; 9:45-10:00, Sport talk by Sam Taube; 10:00-10:30, American Warblers' Harmony Aggregation; 10:30-10:45, Robert S. Williams, John Hill and the Trianon Melody Ensemble; 10:45-11:00, Adelaide Lols Bourne, concert soprano.

**WBAP, Fort Worth, Texas,** (Central, 476), 7:30-8:30 p. m., Concert, Reagan Literary Society, Denton, Texas; 9:30-10:45, Concert, Miss Virginia Jackson.

**WBAV, Columbus, Ohio** (Eastern, 390), 12:00 p. m., Piano music, Ha Lorbach Owens.

**WGX, Detroit, Mich.** (Eastern, 517), 6:00 p. m., Dinner concert; 10:00, Red Apple Club.

**WDAF, Kansas City, Mo.** (Central, 411), 3:30-4:30 p. m., Musical matinee, Joseph Black's Sexton Cafe Orchestra, at The Star's downtown studio, roof garden, Kansas City Athletic Club; 6:00-7:00, School of the Air; Piano tuning-in number, Duo-Art; Address, Clerin Zumwalt, M. A., author and lecturer; Address, speaker from the Meat Council of Greater Kansas City; The Tell-Me-a-Story Lady; Music, Fritz Hanlein's Trianon Ensemble, Hotel Muehlebach; 11:45 p. m.-1:00 a. m., the "Merry Old Chief," and the Coon-Sanders Orchestra, Hotel Muehlebach.

**WDAP, Chicago, Ill.** (Central, Daylight Saving, 360), 7:00-8:00 p. m., Drake Concert Ensemble and Blackstone String Quintette; 8:00-8:30, Barton Organ played by Ralph Emerson; 10:00, Rosemary Hughes, Frederick W. Agard, Boris Worthley, Tom Malle and Jack Little, Jack Chapman's Orchestra.

**WDAR, Philadelphia, Pa.** (Eastern, Daylight Saving, 395), 11:45 a. m., Daily Almanac; 12:02, Organ recital; Stanley Theater; 12:30, Arcadia Cafe Concert Orchestra; 2:00, Arcadia Cafe Concert Orchestra; 7:30, Dream Daddy's bedtime stories.

**WEAF, New York, N. Y.** (Eastern, Daylight Saving, 492), 11:35, Motion Picture talk; 3:30 p. m., Evelyn G. Smith, soprano; 4:00, Capitol City Celebrities Orchestra; 5:00, Children's Program; 7:30, Thornton Fisher; 7:40, Charles Mertens, baritone; 8:00, Corn Products Orchestra; 8:30, Brooklyn Eagle News Review; 9:00, Helen DeWitt Jacobs, violinist; 9:20, Talk on Blue Ribbon Mayonnaise; 9:30, Sophie Irene Loeb; 9:40, American Olympic Committee; 10:00, Eveready Program.

**WEAO, Columbus, Ohio** (Eastern, 360), 1:30 p. m., Garden talk.

**WFAA, Dallas, Texas** (Central, 476), 12:30-1:00 p. m., Address, DeWitt McMurray; 8:30-9:30, Dramatic and Musical program, Council of Jewish Juniors, Mrs. Jules Cahn, director; 11:00-12:00, Music, Lone Star Five Orchestra, Ray W. Ogden, director.

**WFI, Philadelphia, Pa.** (Eastern, Daylight Saving, 395), 1:00 p. m., Meyer Davis Bellevue Stratford Concert Orchestra; 6:00, Sunny Jim, the Kiddies' Pal; 6:30, Meyer Davis Bellevue Stratford Concert Orchestra.

**WGR, Buffalo, N. Y.** (Eastern, Daylight Saving, 319), 12:30-1:00 p. m., George Albert Bouchard, organist; 2:30-4:00, The Radio Dealers Musical Program; 6:00-6:30, Chamber Music Recital; 8:00-8:10, Address, "Making Men and Boys a Bigger Community Asset," A. H. Whitford, general secretary, Buffalo, Y. M. C. A.

**WGY, Schenectady, N. Y.** (Eastern, 380), 5:30 p. m., Dinner music, Instrumental Trio of Hotel Ten Eyck; 7:45, "Facts and Fallacies about Heredity," Dr. James W. Mayor; Elmer Wiese, bass; Isabelle Merwitz, reader; Musolf's Symphony Orchestra; "One Hundred Miles Under the Earth," Rev. L. R. Akers; Karl Wick, bandolinist.

**WHAS, Louisville, Ky.** (Central, 400), 4:00-5:00 p. m., amateur Theater Orchestra; Alamo Theater organ; 7:30-9:00, Concert, Employees of the Louisville Gas and Electric Co., Agricultural Tabloid talk.

**WHB, Kansas City, Mo.** (Central, 411), 12:35-1:00 p. m., Popular music, Sweeney Radio Orchestra; 2:00-3:00, Ladies' Hour program, Sweeney Radio Orchestra; 7:00-7:30, Classical program, Sweeney

Radio Orchestra; 8:00-9:00, Program by the Ministers' Quartette; 9:00-10:15, Sweeney Radio Orchestra.

**WIP, Philadelphia, Pa.** (Eastern, Daylight Saving, 509), 1:00 p. m., Organ recital, Karl Bonawitz; 6:00, Dick Regan and His Wip Little Symphony Orchestra; 7:00, Uncle Wip's bedtime stories; 10:15, Ted Weem and His Record Making Orchestra from Cafe L'Aiglon.

**WJAX, Cleveland, Ohio** (Eastern, 390), 7:30 p. m., Concert program arranged by Cleveland News-Leader; Bedtime story, E. G. Johnson; Radio Cartoon Talk, Don Palmer; Talk, Wm. M. Milliken, director Cleveland Museum of Art; Baritone solos, Joseph D'Angelo; Soprano solos, Grace M. Bigelow; Orchestral selections; Organ recital, Vincent H. Percy, organist Cleveland Auditorium.

**WLW, Cincinnati, Ohio** (Eastern, Daylight Saving, 309), 10:00 p. m., Seventy-eighth Anniversary Cincinnati Typographical Union No. 3, Adolph and Herbert Sidersack, Mrs. August A. Lamping, Mrs. Anna Varrelman-Bramm, James Morris, George F. Woehler, soloists, Miss Ellen Harvey, pianist; Addresses, Thomas J. Donnelly, secretary Ohio State Federation Labor; William J. Cain, president I. T. U. No. 3; Adolph Kummer, president Central Labor Council; 12:00 midnight, Chubb-Steinberg Orchestra.

**WMAQ, Chicago, Ill.** (Central, Daylight Saving, 447.5), 4:30 p. m., Glenn Dillard Gunn School; 8:40, Hotel LaSalle Orchestra; 9:15, Corydon Smith Orchestra.

**WOO, Philadelphia, Pa.** (Eastern, Daylight Saving, 509), 11:00 a. m., Organ recital, Mary E. Vogt; 12:02 p. m., Wanamaker Crystal Tea Room Orchestra, Robert E. Golden, director; 4:45, Organ recital, Mary E. Vogt.

**WOQ, Kansas City, Mo.** (Central, 360), 3:00-3:30 p. m., Music, Edison Recreation; 8:00-9:30 p. m., Popular concert.

**WOR, Newark, N. J.** (Eastern, Daylight Saving, 405), 6:15-6:30, Halsey Miller and His Orchestra; 6:30-7:00, "Man in the Moon" Stories for Children; 7:15-7:30, Halsey Miller and His Orchestra.

**WRC, Washington, D. C.** (Eastern, 469), 6:00 p. m., Children's stories and songs, Marguerite Meakin, Peggy Albion; 7:00, Crandall's Tivoli Theater; 7:45, Dance program; 8:45, Lucian A. Marsh, baritone; 9:00, "The Political Situation in Washington Tonight," Frederick William Wile; 9:15, Trio, Irving Boernstein's Wardman Park Hotel Orchestra; 9:40, Songs; 10:00, To be announced.

**WSB, Atlanta, Ga.** (Central, 429), 8:00-9:00 p. m., Presidential campaign burlesque, Journal Hired Hands; 10:45, Baltimore Rainbow Orchestra.

**WVI, Detroit, Mich.** (Eastern, 517), 8:00 a. m., Setting-up exercises, R. J. Horton; 12:00 p. m., Edward Barnes, baritone; LeRoy DeTurk, tenor; 8:30, Detroit News Orchestra.

## SAMSON

201-A Type, 1/4 Amp. 5 V.

# TUBE

## \$3.50

Send in your C. O. D. order for the tube which is as good as human skill can produce.

Mail orders promptly attended to with Money Back Guarantee

DEALERS' AND AGENTS' TRADE SOLICITED

### PHOENIX TUBE CO.

23 East 26th Street, New York City

Try our

Reliability—Uniformity—Service

## Guaranteed Head-Sets

**RED-HEADS** are guaranteed radio phones. You run no risk when you buy them. Money back if, after 7 days' trial, you're not satisfied that they're the best receivers on the market at the price. Why not act right now and get a pair? It'll mean getting the maximum from broadcasting from the day you put them into use.

### RED-HEAD RADIO RECEIVERS

**NOW READY**

The new 1924 Model F	The new "Red-Head" Jr.
\$6.50 Per Pair Complete	\$5.00 Per Pair Complete

"Red-heads" sent prepaid on receipt of price if you are unable to get them at your dealer's.

**THE NEWMAN-STERN COMPANY**  
Dept. R. D., Newman-Stern Bldg., Cleveland

## Mr. Dealer!!

At \$18.50 the new Crosley Model 51 is taking the radio world by storm. You'll want to know where to get prompt shipments. Here's the place—eight big warehouses ready to supply you immediately with anything you want in radio.

Get our big catalog—sent ONLY to dealers. Ask for A1002. No others need apply.

### WAKEM & McLAUGHLIN INC

225 E. ILLINOIS ST., CHICAGO

## DEALERS PROMPT SHIPMENTS LIBERAL DISCOUNTS

### ERLA Selectoformer

As Usual We Are First With the Latest

Send in your name so we can send you our complete catalog on all the standard lines.

Note!!  
We are the largest exclusive Radio Jobbers in the Middle West

## HUDSON-CROSS

225 W. Madison St. Chicago

**MAGNATRON!** If you insist upon that name when you buy tubes, you are insisting upon obtaining the very best in vacuum tubes. You are assuring yourself of better results from ANY set!

The MAGNATRON DC 201A and the MAGNATRON DC 199 are leaders in their respective fields. At their list price of \$5 they are an outstanding value.

Ask Your Dealer for Magnatrons!

**CONWEY ELECTRIC LABORATORIES**  
309 Fifth Avenue,  
NEW YORK CITY

Price \$1.25

### READ YOUR ANSWER IN THE STARS

The detector question is a very important one to every builder of a reflex radio set, and one that he must answer before he can consider his job really finished.

The STAR FIXT CRYSTAL is the complete answer to this question, and you can get one from almost any live dealer in radio.

Fully Guaranteed. Price \$1.25 everywhere. The crystal is "STAR-ITE"

**STAR CRYSTAL COMPANY**  
525 Woodward Avenue, Detroit, Mich.

Chicago Branch: 53 West Jackson Blvd  
New York Branch: 222 Fulton Street

### ELECTRAD VARIOHM

Doubles Your Distance  
Eliminates Circuit Noises

Correct grid resistance for your tubes and set. From 4 to 30 Meg-ohms by simply turning the knob. Once set, stays permanently. Moisture proof and non-microphonic. Can be used with any standard fixed condenser.

Price 75c; mounted, \$1.00.

At your dealers, or direct. Absolutely guaranteed.

### ELECTRAD, Inc.

423 Broadway New York, N. Y.  
Dept. L



# Two Forms of Loop Aerials; How to Make Them

## Constructional Details and Parts Required

THERE are two good ways of building a loop. These are shown in Figures 1 and 5. In the first, the wires lie all in the same vertical plane and the turns grow smaller as they approach the center. In the second, all wires are parallel in 90° planes and all turns are the same length.

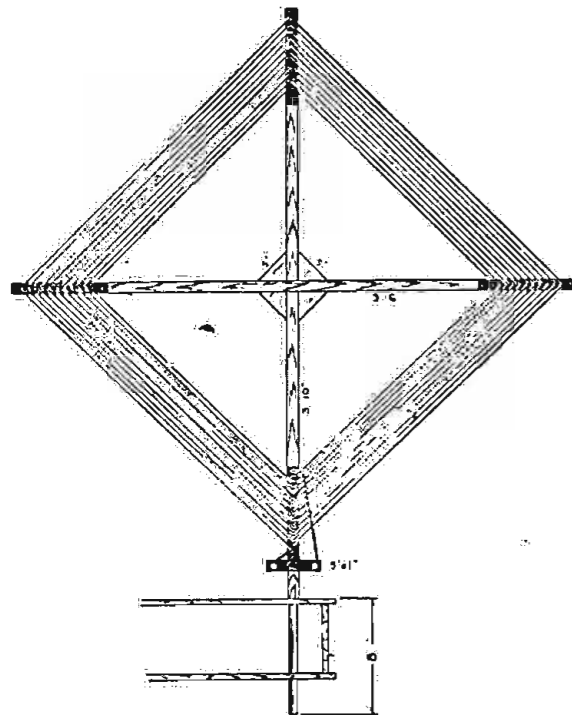

Figure 1

In the construction of the first type, select two straight pieces of wood, 1 inch square, one 3 feet 6 inches long, and the other 3 feet 10 inches long. Notch each of these, halfway through, 1 foot 9 inches from one end so they may be laid together at right angles and lie in the same plane. Then, from a piece of 1/4-inch board cut a piece 5 inches square and bore holes near each of the four corners so that screws can be put through to fasten this piece to the cross, as in Figure 1. Then, from 3/8-inch Bakelite cut four pieces like Figure 2. Fourteen holes should be drilled and

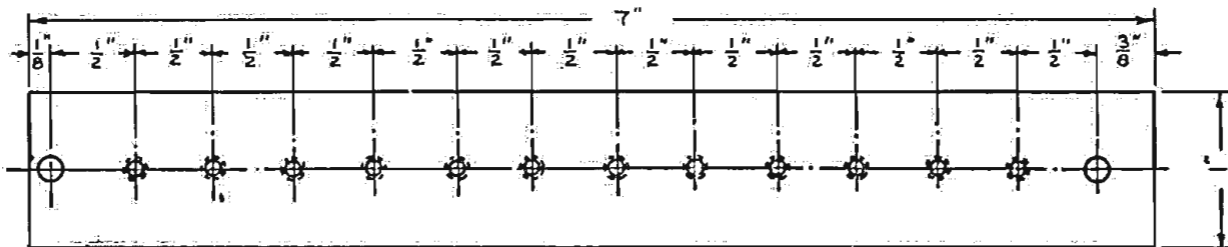

Figure 2

twelve of them tapped for 6-32 machine screws. The two end holes are not tapped, as wood screws fasten these Bakelite pieces to the cross members (again see 1). Before fastening these to the wooden members, insert 7/8-inch, 6-32 machine screws into the 12 tapped holes but screw them only about two-thirds of the way through, leaving 1/8-inch projecting.



Figure 3

Now fasten these Bakelite pieces to the cross arms, 1 foot 2 inches from the center. Leaving 6 inches for connections, wind your wire a couple of times around the bottom screw, carry it to the outer screw on the left side of the horizontal arm; then around the top screw of the vertical piece; then to the outer screw on the right side of the crosspiece, and finally to the second from bottom, next to the one where you started. Continue until eleven turns are on, twist the wire around the last screw, and carry it loosely to lower end. Figure 3 shows a 5 by 1-inch crosspiece of bakelite with binding posts on it. Connect the inner and outer ends of the loop to these.

The lower end of the vertical arm should now be drilled with a 3/8-inch bit and a piece of 3/8-inch bakelite rod, 10 inches long, inserted to a depth of 2 inches. This should be a tight fit. The

supports are made of 1/2 by 3/4-inch material, 5 inches wide and kept 6 inches apart by another piece of the same material.

In constructing the second type of loop refer to Figure 5. The crosspieces and method of supporting this loop are like those of the first. The bakelite wire sup-

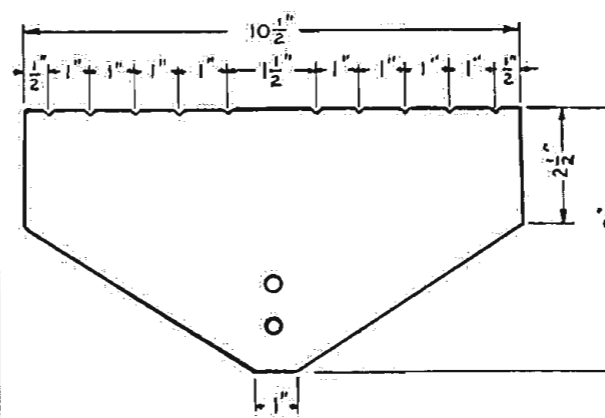

Figure 4

ports are made as shown in Figure 4, four being necessary. From left to right: edge to notch 1/4-inch; then 1/2-inch to second notch; then three more notches 1/2-inch apart; then 1-inch to notch 6; four more notches, 1/2-inch apart. Ten turns of wire are wound around this structure and leads are brought to the binding posts for connection.

### Mounting and Wire

No particular kind of wire can be said to be better than others for loops as they have been wound, and have performed satisfactorily, with bell wire, lamp cord,

silk-covered and cotton-covered, "Litz" and braided bare copper wire. While the larger size loops, 5 to 8 feet sq are, may be slightly more efficient, they are cumbersome and too large to be used in the average home, and the 3-foot size is to be preferred.

Now a few words about the support of loops. The method shown in the construction of the two loops is, in the writer's opinion, best, but loops may be suspended from above, hinged at the side or set upon a base. They may be fastened to

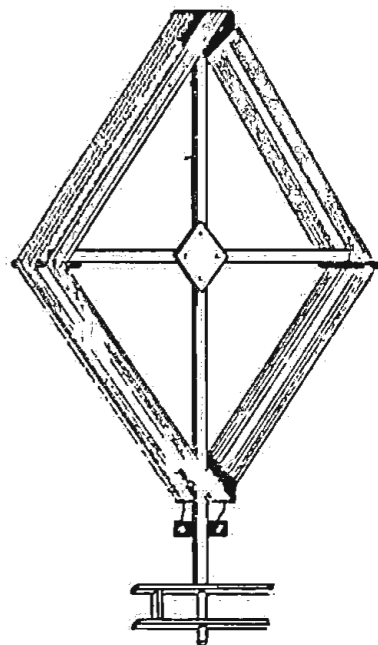
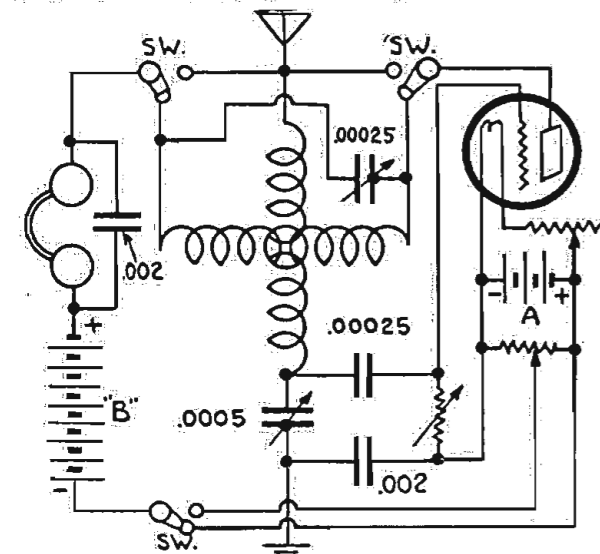

Figure 5

the back of a door and the door swung to obtain directions. Remember, the plane of the loop must be parallel to the direction of travel from various stations. The reader will at once appreciate how this property of the loop serves to eliminate interference from undesired stations.

### Combining Miloplex Circuits in One Set

Has it ever occurred to you that two circuits may be combined, and the same



instruments used for both? This may be accomplished in the Miloplex circuits II and III by wiring them as shown in the diagram. Only three switch levers and

six contact points are required for doing this. This combination will no doubt prove useful in many ways, as one set may give better results with a certain station than another, and gives you two sets to work with.—Evertom-Fisel, Lebanon Junction, Ky.

A short aerial enables a set to tune much more sharply than a long aerial, but the long aerial brings in more energy.

### Super Heterodyne

- Immediate Delivery - Attractive Discounts
- Branton Kit No. R. 100 Complete \$36.50
- Contains—3 Intermediate R. F. Transformers, each.....\$6.50
- 1 Special Transfer Coupler..... 7.50
- 1 Special Oscillator Coupler..... 5.00
- 1 Antenna Coupler..... 4.50
- Book of Instructions with Template, Blue Prints..... 1.00
- All American R 100—75—30 K. C. 10,000 M Transformers.....\$6.00
- Acme 30 K. C.—10,000 M Transformers..... 5.00
- Hilco Oscillating Coupler..... 7.00
- Hilco Antenna Adjustable Coupler..... 8.00
- Complete Stock of FADA Kits and Sets 128 Page Catalog No. L25 FREE
- AMERICAN RADIO MFG. CO.**  
Dept. V, 6 West 14th St. Kansas City, Mo.

### RADIO PIN-MAP

of United States, Canada and West Indies with indexed booklet broadcasting guide.

Spot Stations You Have Heard with Colored Map-Pins

Map size, 22x14 in., mounted on map-pin board. Shows all broadcasting cities, distance scale, relay and time divisions. Guide gives all call signals, locations, stations, wave lengths, etc. Price complete, 85c. Map-pins, 10c per doz. Any color. Above booklet with folded paper map, 35c. At your dealer or direct.

**AMERICAN MAP CO.**  
MAP MAKERS PUBLISHERS  
7 W. 42d ST., Dept. R. NEW YORK  
Dealers and Representatives Wanted

**3000 mile**

**RADIO "B" BATTERIES**  
At Factory Prices

Greatest Radio "B" battery on market. Full number voltage taps; QUALITY GUARANTEED; LOWEST PRICES; brings in concerts LOUDER AND STRONGER; will work on any tube or loud speaker. Order by number TODAY with check, money order or pay postman C. O. D.

No. 322B—22 1/2 volt, variable, regularly \$2.25..... **\$1.55**

No. 322A—22 1/2 volt, variable, regularly \$3.00..... **\$1.82**

No. 345A—45 volt, 8 taps, regularly \$5.50..... **\$3.25**

AYRES BATTERY CORPORATION, Cincinnati, Ohio

**RADIO FREE SETS BUILT FREE**

If you purchase the parts from me at standard prices,

**Any Type of Set Built**

Expert workmanship assured. Only the very best parts used.

Correspondence invited.

**HERMAN E. ERICKSON**  
(Associate, Institute of Radio Engineers)  
ONE UNION SQUARE—NEW YORK CITY

Do Not Ask for a Grid Leak

Ask for a

**DAVEN RESISTOR**

It is just as easy and means a lot more.

**DAVEN RADIO**  
8 Campbell St. NEWARK, N. J.

**USE IT ANYWHERE**

**PENTZ RADIO FACTORY**  
207-S. 5TH ST. MPLS. MINN.

(Two-thirds actual size)

**DISTANCE** Five miles without any aerial. With aerial 10 miles.

**No Coils, Batteries, Tuning**

Sample dozen sent to dealers at wholesale price upon \$5 deposit. Balance C. O. D.

**TUNE IN TONIGHT WITH MAGNITE**

**FIFTY CENTS**

**THE LOUD TALKING CRYSTAL**

Sold on a Money-Back Basis

Try One and Be Convinced Sensitive All Over

Manufactured by **THE MAGNITE LABORATORIES**  
P. O. Box 472, Newark, N. J.

For Sale at all Leading Radio Stores

Distributed by **The Radio Shop of Newark, Inc.**  
76 Springfield Ave., Dept. B, Newark, N. J.

**TUBES REPAIRING REBUILDING**

ALL TUBES REPAIRED

Guaranteed Like New

Detectors or Amplifiers... **\$2.65**

One Amp., 6 Volt Tubes Changed to 1/2 Amp. Tubes

Write Today for Tube Circular on New and Refilled Tubes

**American Radio Tube Works**  
Irvington, New Jersey, U. S. A.  
AGENTS WANTED EVERYWHERE

**RUSONITE**

**FIXED DETECTOR**

ONE ADJUSTER—BAKELITE BASE  
GUARANTEED—PRICE \$1.25

Rusonite Perfect Radio Crystal, Supersensitive..... Price Mounted 50c

Rusonite 14K Gold Cat Whisker..... Price 25c

**RUSONITE PRODUCTS CORP.**  
15 Park Row New York  
RUSONITE PRODUCTS CHICAGO  
25 E. Jackson Blvd.

**Less Noise -- New Stations**

"The range of your vacuum tube, with circuit noises and interference eliminated, has practically no limits. Phenomenal ranges are attained by receivers absolutely silent in operation, while needless noises only rack your nerves."

**The "Radio Trouble Shooter"**

Off the press March 15, 1924. A plain, practical, useful book you need if by circumstances you are obliged to keep your radio set in working order yourself.

A book by experienced trouble-shooters. It tells you in plain street corner English what to do to locate and remedy troubles, not only loud noises but those faint, hissing, fizzling sounds that indicate distortion and prevent reception from distant stations.

Simple troubles first, then goes right to the bottom of radio troubles, their prevention, systematic search for trouble, trouble key, efficiency test systems, hints for better reception, secret of distance, elimination of interference from hissing, frying, scratching sounds. Applies to any type receiver. Enables you to make a home-made set as efficient and quiet as though factory built. Invaluable test systems to the experimenter who has set up a new circuit and wants to know quickly why it doesn't work.

Already sold in forty states and Canada. The luckiest fifty cents you will ever put into radio. Book postpaid return mail only fifty cents.

**Radio Information Service, Publishers**  
GALVESTON, TEXAS

**Perfection Coil Antenna**

Eliminates the Outside Aerial

**PERFECT RECEPTION**

NO ROOF ACROBATICS  
REDUCES STATIC AND INTERFERENCE  
INCREASES SELECTIVITY

*Just stretch it Across a Room*

At your Dealer's or Direct

**Price \$2.00**

Postpaid

**Perfection Radio Mfg. Co.**  
24th and Race Streets PHILADELPHIA



# Questions and Answers

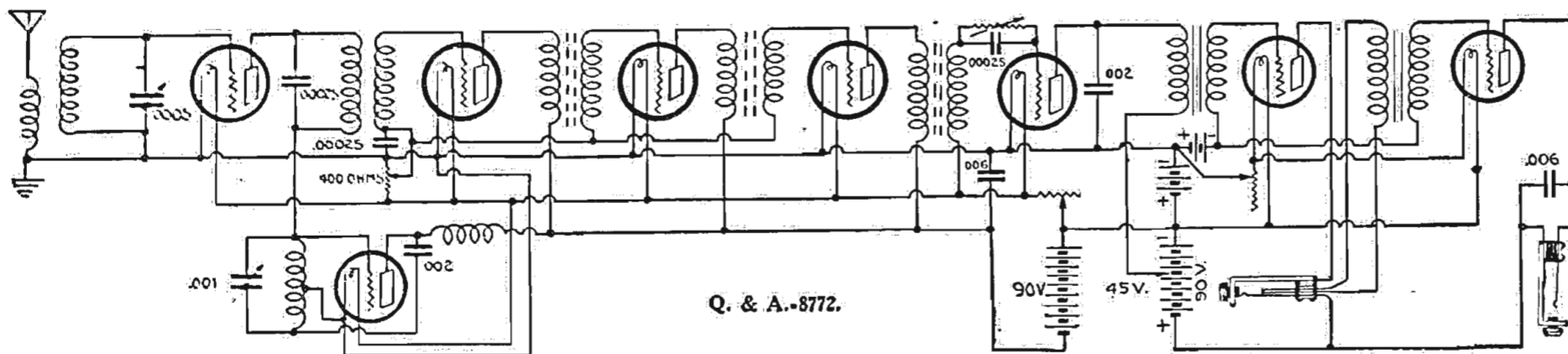

Q. & A.-8772.

### Super-Heterodyne Correction

(8772) WFE, West Chester, Pa.  
 In reference to the latest in super-heterodyne, as explained by H. J. Marx on page 21, kindly explain how the oscillator and second tube can be made to light. As per sketch they are both connected to the minus side of A battery. I trust you will not take offense and will send to me a sketch of the super-heterodyne using an outside antenna. As a reader of your magazine, I must confess this is the first heterodyne that looks workable to me.

A.—The error was in the omission of the connection to the one side of the A battery feed. This has been corrected in the diagram shown above. A fixed coupler is indicated for using an outdoor antenna as requested. This coupler has a primary winding of 6 turns of number 20 dec. wire and a secondary of 50 turns of the same wire wound on a 3-inch tube. The windings are spaced 1-inch apart and both run in the same direction. The start of the primary winding is the antenna, and the corresponding starting terminal of the secondary is the grid connection. The circuit will give very satisfactory results.

### Antenna

(07933) RAF, Huntingdon, Pa.  
 I would like to ask a few questions regarding "A Good Indoor Antenna," which appeared in the Radio Digest, issue of February 16, on page 24. Is it absolutely necessary that the wire used be single strand? Is the wire left on the tube after winding? Can I use 150 feet of number 15 insulated lamp cord for this purpose?

A.—A single strand wire is recommended for the construction of the indoor antenna system as described in February 16 issue of Radio Digest. The wire is stretched like a coiled spring and must permit of springing.

If for outdoor use, we would recommend a single strand antenna system. Lamp cord will serve for construction.

### Neutro and Super-Het!

(7354) LGR, Niles, Ohio.  
 Would it be possible to incorporate the principles of the Super-Heterodyne and Neutrodyne receivers in one set? My idea was to wind the Neutroformers for a wave length of 10,000 meters but have each one tuned with a fixed condenser. Would a 600-turn secondary with a 150 primary on a 2-inch tube with secondary shunted by a .001 mfd fixed condenser be right?

A.—While your contemplated combination of the Neutrodyne and Super-Heterodyne principles is possible it offers a debatable advantage because of the negligible effect tube capacity would have at a 10,000 meter wave length.

We have not considered constructional data for winding Neutroformer to conform to your specifications.

RADIO TUBES, Sold, Exchanged, Repaired. Free Circular. AMERICAN RADIO TUBE WORKS, IRVINGTON, N. J., U. S. A.—Adv.

### Buy Your Tubes Direct

A \$6.50 Value for \$3.50. Absolutely guaranteed. SENT PREPAID IN 24 HOURS  
 Type 201-A—6 volt, 1/2 amp. Amplifier  
 Type 200—6 volt, 1 amp. Detector  
 Type UV-199, 3 volt, .06 amp. Detector or Amplifier  
 Type WD-12, 1 1/2 volt, 1/2 amp. Detector or Amplifier  
 2 Tubes \$6.90; 3, \$10.40; 4, \$13.60; 5, \$17; 6, \$20  
 Factory Sales Representative FRISCO TUBE CO. 15 West Erie St. Chicago, Ill.

### SPECIAL INTRODUCTORY OFFER NEW MASTER TUNING UNITS

SHARPER SELECTIVITY—DISTANCE—QUALITY  
 711—Aerial Tuner, Lattice Type.....\$3.65  
 712—Tuned Impedance, Lattice Type... 3.75  
 721—Tuned R. F. Transformer, Lattice Type..... 3.95  
 732—3 Circuit R. F. Transformer, with Tuned Plate..... 4.35  
 Prompt Shipments—Postpaid on Receipt of Order with Remittance  
**ESTRU** 2905 WEST MADISON ST. CHICAGO

### Kopprasch Corrections

In your issue for March 22, on page 30, you will find a hook-up for the Kopprasch circuit. From the general layout of the diagram, it seems to have some serious omissions.

The main point of its design is that the phones and the principal controls are as near as possible at ground potential, to avoid body capacity. Your diagram of it jumps over this important ground con-

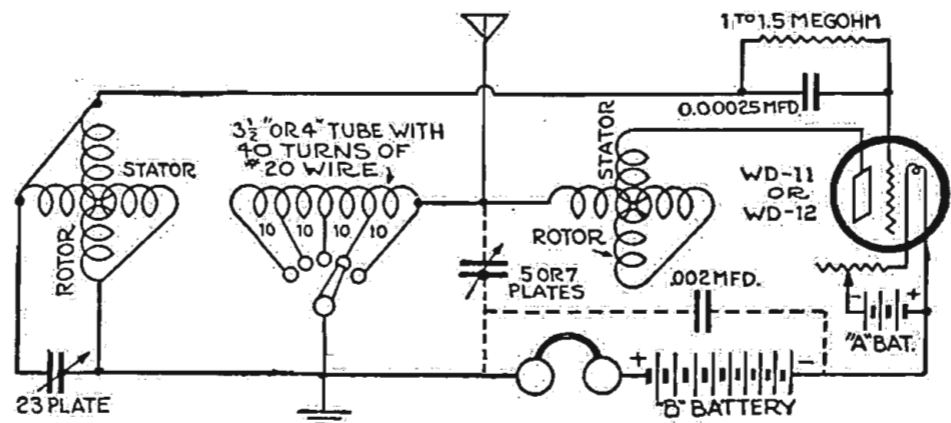

nection, and omits the phones, the grid condenser and grid leak. I hope you will kindly apprise the questioner, JWJ of Chicago, of these corrections before he goes ahead with any disappointing construction.

Here is the corrected diagram. The 23-plate condenser was not shown in the first design of the instrument, but was added to take care of long waves. It might be well to put a condenser or other tuning device in the aerial circuit to tune it more closely, and it might also be well to shunt the phones and B battery with a small phone condenser of say .002 mfd. These extras are shown by the dotted lines.

ROGER P. HELLER,

Route 5, Canton, Ill.

### Reflex Whistle

(08004) S. T. Sanitorium, Colo.  
 I have a DeForest D-7A 3-tube reflex set and recently it developed a whistle that I can't get rid of. The whistle is there all the time, never ceases, but comes on as soon as I light the tubes. It sounds like a whistle on a peanut stand. Could you tell me my trouble?

A.—We have carefully noted difficulties developed in operating your described re-

ceiver. It is evidenced that one of your transformers is not functioning effectively, possibly because of moisture, causing shorts between turns or layers. This can be determined by connecting transformer primary, telephone and batteries in series. If this is true, place unit in oven and dry out at a moderately high temperature and impregnate with paraffin. Before resorting to this, however, try connecting a pencil line grid leak across the secondary of transformer, increasing until the whistle ceases.

### Neutrodyne Trouble

(07212) EOB, Bridgeport, Conn.  
 The writer is operating a 5-tube Neutrodyne receiver at what seems to be an ideal location, in the country section.

Trees are fairly abundant, although I have arranged my aerial in the open as much as possible. Aerial is strung from tree to tree, perhaps 100 feet long, about 35 feet high at the far end, and 16 feet on the receiving end. I have a practical ground, sheet copper buried in charcoal about 3 feet deep, so I am advised.

At some intervals I can get reception on a loud speaker audible 50 to 60 feet from horn; other times the signals can be heard but very faintly and at that with much interference, making it almost impossible

## CUT OUT STATIC and interference

Don't put your set away for the summer on account of that troublesome interfering static that comes busting in every time you get some favorite station.

You will be surprised at the ease with which you can

### Eliminate Static and Interference

Costs less than a dollar to equip any type of set, crystal, regenerative, reflex, neutrodyne, and with practically any size of antenna. We are getting coast to coast stations any night on loud speaker without interference.

You can get the same results. Send stamped addressed envelope for further information. WRITE TODAY.

CAMBRIDGE RADIO LABORATORY  
 101 East Exchange St. Cambridge, Ill.

11 FEET LONG  
 12 INCHES DIAMETER  
 Substitute for Outside Antenna  
 110 Feet Stranded Copper Wire  
 NOT A LOOP BUT A FULL SIZE ANTENNA  
 Often doubles tone getting for stations in series with outside antenna  
 Suspend near ceiling  
 NO DANGER from LIGHTNING  
 \$7 COMPLETE POSTPAID

Or \$5, if our set owner's addresses are sent to us.  
 INTER-STATE SIGNAL CO., DEPT. I, COLUMBUS, O.

## Complete Parts

- 5-Tube Hazeltine Neutrodyne.....\$32.95
- 4-Tube Superdyne..... 28.50
- 3-Tube Ambassador..... 24.45
- 1-Tube N. Y. Journal 1-knob set..... 8.45
- Royaltron Tubes, best for Volume, guaranteed for 1 year.....\$3.50
- \$5.00 American Speaker Units..... \$2.65
- 5.00 American Radio Phones..... 3.15
- 5.00 Peerless Professional Phones..... 2.85
- Cockaday Coils..... 1.55

Many other items—No dealers supplied  
 Write for latest price list  
 Mail Orders Filled C. O. D.

Orders over \$10, send 25% deposit. Balance C. O. D.

**N. Y. RADIO OUTLET**  
 296 Broadway, New York City

### "Kills Reflex Troubles"

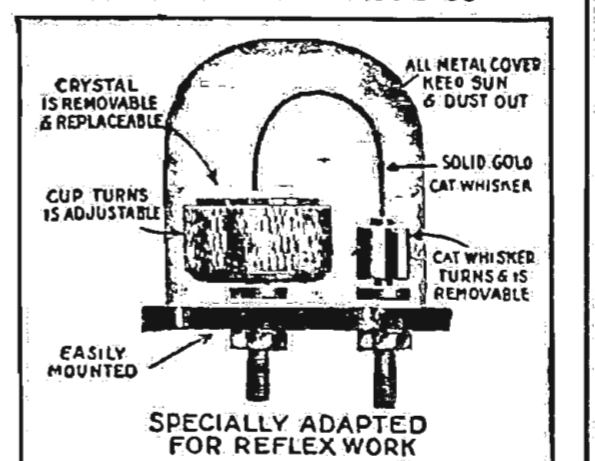

"Lincoln" Detector  
 Creating tremendous sensation. Enclosed, fixed, adjustable. New. Brings in distant stations loud and clear. You need it. Ask your dealer or write today. Price only \$2.00. Absolutely guaranteed for one year.  
 Jobbers, Dealers: Wire or write. Mention this ad.  
**LINCOLN MFG. CO.**  
 Dept. N-3 Los Angeles, Calif.

to clarify. A new 100 hour A battery gave service for but about 20 hours when it had to be recharged. It has been in use now about that same length of time and the signals which were first very loud and clear, now seem to be gradually diminishing in volume, as before.

Perhaps you can, from my description, offer me some suggestion to overcome my difficulties. If the little prongs or contacts on the tubes UV-201A are loose, will this cause such conditions?

A.—We have noted carefully limitations encountered in operation of Neutrodyne circuit. Judging from the action cited it would appear that there may be a short circuit which is consuming current when the set is not in operation. We are advising that this be determined by testing. Turn the filament of the tube off and by means of a meter note whether or not current is being consumed. The conditions of loose prongs could hardly be responsible.

It may be that your A battery is defective. Dead B batteries could also be responsible.

A diagram of circuit would have been helpful in isolating any discrepancy in circuit.

### Crystal Wave Trap

(07087) JH, New York City, N. Y.  
 My Radio frequency set tuned very broad with plenty of interference. A wave trap did not help at all. I took a two slider crystal set, hooked it to the ground and aerial and connected phone posts to aerial post on tube set, and it did the trick! The tube set is also grounded.

I believe the publication of this letter will be a boon to many set owners, and would like to hear from any experimenters along this line.

The crystal also clears the reception.

A.—We are advising in your inquiry that connection of crystal detector to your tube set in the manner described provided a wave trap and is of value in increasing selectivity.

We appreciate your interest in passing on your experiment for the benefit of our readers.

PATENTS procured. Send sketch or model today for examination, prompt report and advice. No charge for preliminary advice. Write for free Booklet and blank form on which to disclose your idea. Highest references. Promptness assured. Clarence A. O'Brien, Registered Patent Lawyer, 200-C Security Bank Building. Directly across the street from Patent Office, Washington, D. C.

### Have you found the Coupler you were looking for?

We have 4 styles, all bakelite tubes and bakelite rotors, wound with silk-covered wire, for all wave lengths; the famous 2-rotor coupler which does not use any variable condensers in the hook-up; blueprint with each coupler. All makes of transformers, including the push-pull type, wave traps, wave meters and inductances of all kinds which make better tuning possible. Famous Brandes matched tone receivers, all other makes; Trinity loud speaker. Can furnish parts for super-heterodyne and Hazeltine neutrodyne. A and B batteries, battery chargers, Perfection rheostats and potentiometers, grid leaks, plugs and condensers of all kinds. Cabinets built to order. Price list mailed on request. Your business solicited.

PERFECTION RADIO SHOP  
 206 So. Lebanon St. LEBANON, IND.

### Nath. Baldwin Phones with

Complete \$8  
 Regular Value \$15.  
 Postpaid. Use your headset for two purposes—exceptional combination value—every pair of phones tested.  
 Walter Scott & Co. 66 Heller Pky, Newark, N.J.

## Lambert's Reach-Out Crystals

The kind I use on my famous DX Crystal Sets that reach out and bring in concerts

400 to 1000 Miles Away

Mounted 60c each, two for \$1.00.  
 Unmounted 40c each, three for \$1.00.  
 Fixed detector, \$1.50. Mailed postpaid the day I get your order.

### Leon Lambert

501 So. Volusia, Wichita, Kansas



# Radiophone Broadcasting Stations

## Corrected Every Week—Part I

**AAS**, Denver, Colo. 440 meters. Fitzsimmons Gen. Hospital. (Educational Dept. U. S. Army). Thurs, 7:30-8:30 pm, music, entertainment. Mountain.

**AQ6**, Canton, O. 425 meters. 11dtrs. 135th Field Artillery Co. N. G.

**AV7**, St. Paul, Minn. 400 meters. 6th Inf. Minn. Nat'l. Guard, St. Paul Armory. Irregular schedule. Central.

**AW5**, Dayton, O. McCook Field, U. S. Army. Experimental work only.

**BE1**, Tacoma, Wash. 400 meters. 50 watts. (Camp Lewis, U. S. Army, Third Signal Corp. Discontinued indefinitely).

**CFAC**, Calgary, Alta., Can. 430 meters. 1000 watts. Calgary Herald. Daily ex Sun, 1 pm, 3:30-4:30, 7:30-8:30 pm, music, news, entertainment. Mountain.

**CFBC**, Vancouver, B. C., Can. 400 meters. 1000 watts. Daily ex Sun, 12 m, weather, news, stock; 5:30-6 pm, news; 8-9 pm, music. Sun, 7 pm, church services. Eastern.

**CFCE**, Montreal, P. Q., Can. 440 meters. 400 watts. Marconi Wireless Tel. Co. Daily 1-1:30 pm, Mon, 7:30-12 midnight; Wed, 6-8 pm; Fri, 7:30-12 midnight, music, entertainment, reports. Eastern.

**CFCH**, Ingoquois Falls, Ont., Can. 400 meters. 250 watts. Abitibi Power & Paper Co., Ltd. Slogan, "The Call of the North." Experimental station for forest protection.

**CFCL**, Quebec, Que., Can. 410 meters. La Cie de L'Evenement.

**CFCK**, Edmonton, Alta., Can. 410 meters. 115 watts. Radio Supply Co., Ltd. Daily ex Sun, 8-8:45 pm, music. Sun, 3:30-4:30 pm, Concert. Mountain.

**CFCL**, Victoria, B. C., Can. 400 meters. 500 watts. Centennial Methodist Church. Slogan, "Where Religion Cheers." Tues, 8:30-10:30 pm, concerts, lectures. Sun, 11 am, 7:30 pm, church services. Pacific.

**CFCN**, Calgary, Alta., Can. 440 meters. 500 watts. W. W. Grant Radio Ltd. Slogan, "Voice of the Prairies." Tues, 11:30-1:30 am, Broncho Busters. Sat, 10-12 pm, dance music. Test program, Sat. after midnight. Mountain.

**CFCO**, Bellevue, P. Q., Can. 450 meters. Semmelhaeck-Dickson, Ltd. Daily ex Sun, 9:45-10:30 pm, news, markets, reports, sports, time, music. Sat, 9:30-11 pm, music. Sun, 9:15-10:45 pm, sacred music. Eastern.

**CFCC**, Vancouver, B. C., Can. 450 meters. 10 watts. Radio Specialties, Ltd. Tues, Thurs, Sat, 7:30-8 pm, music. Wed, 4-5 pm, music. Sun, 8:30-9:30 pm, classical music. Pacific.

**CFCR**, Sudbury, Ont., Can. 410 meters. 100 watts. Laurentide Air Service, Ltd. Daily ex Sun, 1 pm, 6 pm, stocks, financial news. Wed, 8:30 pm, Eastern.

**CFCW**, London, Ont., Can. 420 meters. 500 watts. London Radio Co. Irregular schedule.

**CFDC**, Nanaimo, B. C., Can. 430 meters. 10 watts. Sparks Co. Mon, Wed, Fri, 7:30-8 pm, Pacific.

**CFDE**, Saskatoon, Sask., Can. 400 meters. 250 watts. The Electric Shop, Ltd. Slogan, "The Hub City of the West Where No. 1 Northern Hard Wheat Grows." Daily ex Sun, 1-1:30 pm, markets, reports, music. Mon, Tues, Thurs, Fri, 7:30-9 pm, news, reports, markets, entertainment. Sun, 9-9:45 pm, church services. Mountain.

**CFER**, Kingston, Ont., Can. 450 meters. 500 watts. Queen's University. Discontinued temporarily.

**CFEU**, Montreal, P. Q., Can. 400 meters. Univ. of Montreal.

**CFEX**, New Westminster, B. C. 440 meters. Westminster Club.

**CFYC**, Vancouver, B. C. 400 meters. Victor W. Oillum.

**CHAC**, Halifax, N. S., Can. 400 meters. 20 watts. Radio Engineers.

**CHBC**, Calgary, Alta., Can. 410 meters. The Alberta Pub. Co. Daily ex Sat, 8:45-9 pm, news, stock quotations, music. Mountain.

**CHCB**, Toronto, Ont., Can. 440 meters. Marconi Wireless Tel. Co.

**CHCD**, Quebec, Que., Can. 410 meters. Canadian Wireless and Electric Co. Mon, 7:30-9 pm; Wed, 8-9 pm, Sat, 8-10 pm, music. Eastern.

**CHCE**, Victoria, B. C., Can. 310 and 400 meters. Western Canada Radio Suppl. Ltd. Slogan, "The Voice of the Island." Daily ex Sun, 7-8 pm, music, stock reports, entertainment. Sun, 9-10 pm, music entertainment. Pacific.

**CHCL**, Vancouver, B. C., Can. 440 meters. 2000 watts. The Vancouver Merchants Exchange, Ltd.

**CHCM**, Calgary, Alta., Can. 430 meters. 500 watts. Riley & McCormick Ltd. Thurs, 7:30-8:30 pm, musical. Mountain.

**CHCS**, Hamilton, Ont. 410 meters. Hamilton Spectator Bldg.

**CHYC**, Montreal, Que., Can. 311 meters. 500 watts. Northern Elec. Co. Wed, 8:30 pm, Sun, 7 pm, Eastern.

**CJCA**, Edmonton, Alta., Can. 450 meters. 500 watts. Edmonton Journal, Ltd. Slogan, "The Sunniest Spot in Sunny Alberta." Club, "Igloo Hut." Daily ex Tues and Sun, 12:30 pm, weather, markets, 7:30-8 pm, Children's half hour. 8:30-9:30 pm, concert, reports. Thurs, 10:15 pm, Igloo Hut meetings. Mountain.

**CJCD**, Toronto, Ont., Can. 430 meters. T. Eaton Co. Daily ex Sat, Sun, 4-4:30 pm, music. Eastern.

**CJCE**, Vancouver, B. C., Can. 420 meters. Sprott-Shaw Radio Co. Daily ex Sun, 12:30-1:30 pm. 3:30-5-8:10 pm, music, news. Pacific.

**CJCI**, St. John, N. B., Can. 400 meters. Maritime Radio Corp., Ltd. Mon, Wed, Fri, 7:30-9 pm, music. Sat, 9-11 pm, music. Eastern.

**CJCM**, Mont Joli, P. Q., Can. 312 meters. 250 watts. Dr. J. L. P. Landry. Slogan, "Three weeks below Quebec where civilization nearly ends." Daily ex Sun, 5-6 pm, music, news; 11-12:30 am, Radio vaudeville. Wed, Sat, 8:30-10:30 pm, music. Eastern.

**CJCN**, Toronto, Ont., Can. 410 meters. Simons, Agnew & Co. Signals.

**CJCA**, Olds, Alta., Can. 400 meters. 200 watts. Percival W. Shackleton. Slogan, "Echo from the Rockies." Daily ex Sun, 6:45-7:45 pm, music, news, time, entertainment. Mountain.

**CJGC**, London, Ont., Can. 430 meters. 100 watts. London Free Press. Daily ex Sun, 7:15-8:15 pm, news market and weather, music, entertainment. Eastern.

**CJSC**, Toronto, Ont., Can. 430 meters. The Evening Telegram.

**CKAC**, Montreal, Que., Can. 425 meters. 1,200 watts. La Presse. Wed, Fri, Mon, 1:45 pm, orchestra. Daily ex Sat, Sun, 11 pm, music; 4:30 weather, markets, stocks. Tues, Thurs, Sat, 7 pm, children's hour; 7:30, concert; 10:30, specials. Sun, 4:30 pm, sacred concert. Eastern.

**CKCD**, Vancouver, B. C., Can. 410 meters. 2,000 watts. Vancouver Daily Province. Daily ex Sun, 8:30-9:30 pm, music, news, entertainment. Pacific.

**CKCE**, Toronto, Ont., Can. 450 meters. 750 watts. Can. Ind. Telephone Co. Occasional programs. Canadian National Railway. Evening program, Wed, Sat.

**CKCK**, Regina, Sask., Can. 420 meters. 500 watts. Leader Pub. Co. "The Queen City of the West." Daily ex Sat, Sun, 9:54 time; 10:10-10:30 am, 1:15-2 pm, 7:30-8:15. Tues, 7:30-9 pm, music, entertainment, news, market, weather. Sat, silent night. Sun, 9 service. Mountain.

**CKCO**, Ottawa, Ont. 400 meters. Dr. G. M. Geldert (Ottawa Radio Assn.).

**CKCX**, Calgary, Alberta, Can. 440 meters. 500 watts. P. Burns & Co., Ltd. Tues, Fri, 9-10 pm, music, lectures. Mountain.

**CKOC**, Hamilton, Ont., Can. 410 meters. 20 watts. Westworth Radio Supply Co., Ltd. Slogan, "In the Garden of Canada." Mon, Wed, Fri, 8-9 pm, music, entertainment. Sun, 7-8 pm, church services. Eastern.

**CKY**, Winnipeg, Man., Can. 450 meters. 500 watts. Manitoba Tel. System. Daily ex Sun, 12:30-1:30 pm, music, lectures, etc.; 2 pm, grain markets, weather. Tues, Thurs, Fri, 8:15-8:25 pm, bedtime story; 8:25-10 pm, music, lectures. Sun, 7 pm, church services. Central.

**CYB**, Mexico City, Mex. 370 meters. 500 watts. El Buen Tono, Tues, Sat, 7:30-9 pm, Thurs, 8-10 pm, concert. Mexican time.

**CYX**, Mexico City, Mex. 500 meters. 510 watts. La Casa de Radio. Tues, Fri, 9-10:30 pm, Mexican.

**CYX**, Mexico City, Mex. 500 watts. Excelsior-Parker.

**ESP**, Paris, France. 450 meters. 450 watts. Superior School P. T. T.

**HBI**, Geneva, Switzerland. 1100 meters. 600 watts.

**Marconi's Wireless Telegraph Co., Ltd.** Daily ex Sun, 3:15 pm, music, news. Swiss.

**KBELV**, Prague, Czechoslovakia. 1150 meters. 1000 watts. Radio-Journal Broadcasting Co. Daily ex Sun, 10 am, 11:30, 1:30, 5, 6, exchange rates, stocks, markets; 7:15-8 pm, concert; 8:15-9 concert. European mean time, one hour in advance G. M. T.

**KDKA**, E. Pittsburgh, Pa. 326 meters. 1,000 watts. Westinghouse Elec. & Mfg. Co. Daily ex Sun, 9:45-10 am, 12-1 pm, market reports, music; 6-10 pm, news, features, markets, concert; 9:55-10, time. Sun, 10-45 am, church service; 2:45 pm, concert; 4:45 pm, 7:30, church service; 6:30, dinner concert. Eastern.

**KDPM**, Cleveland, O. 270 meters. 500 watts. Westinghouse Elec. & Mfg. Co.

**KDPT**, San Diego, Calif. 241 meters. 50 watts. Southern Elec. Co. Slogan, "At the End of the Trail." Daily ex Sun, 1:30-2:30 pm, 6:00-6:45. Wed, 8:00-10:00 pm, Sun, 10:00-11:30 am, Pacific.

**KDYL**, Salt Lake City, Utah. 360 meters. 100 watts. Newhouse Hotel. Slogan, "Better Radio." Daily ex Sun, 6:30-8 pm, news, music, entertainment. Mountain.

**KDYM**, San Diego, Calif. 280 meters. 100 watts. Savoy Theater. Mon, Wed, Fri, 8-10 pm, music, entertainment. Pacific.

**KDYO**, Portland, Ore. 360 meters. 100 watts. Oregon Institute of Technology. Slogan, "The Radio School." Educational programs.

**KDYW**, Phoenix, Ariz. 360 meters. 20 watts. Smith Hughes & Co. Temporarily discontinued.

**KDZB**, Bakersfield, Calif. 360 meters. 100 watts. Frank Siefert. Daily ex Sun, Mon, 8-9 pm, reports, music. Sun, sacred program, irregular. Pacific.

**KDZE**, Seattle, Wash. 270 meters. 100 watts. The Rhodes Dept. Store. Daily, 12:30-1:30 pm, Pacific.

**KDZI**, Wenatchee, Wash. 360 meters. 50 watts. Elec. Supply Co. Temporarily discontinued.

**KDZZ**, Denver, Colo. 360 meters. 10 watts. Nicholas Academy of Dancing. Daily ex Sun, 1 pm; 5:30. Mon, 6-7:30 pm, Tues, Thurs, Sat, 9 pm. Sun, 6 pm, 8, 11. Mountain.

**KDZR**, Bellingham, Wash. 261 meters. 50 watts. The Bellingham Pub. Co. Slogan, "Tulip Town." Daily ex Thurs, 7-8 pm, Pacific.

**KFAD**, Phoenix, Ariz. 360 meters. 100 watts. McArthur, Brothers Mercantile Co. Daily ex Sun, 7:30-8:30 pm, news, weather, stock reports, music. Mountain.

**KFAE**, Pullman, Wash. 330 meters. 500 watts. State College of Washington. Slogan, "Your Service Station." Mon, Wed, Fri, 7:30-9 pm, lectures, music, readings. Pacific.

**KFAF**, Denver, Colo. 360 meters. 500 watts. Western Radio Corp. Slogan, "Voice from the Rockies—Out Where the West Is." Mon, Tues, Fri, Sat, 8-9 pm; Thurs, 7:30-8, music, reports, news. Wed, silent. Mountain.

**KFCY**, Lo Mars, Ia. 252 meters. 50 watts. Western Union College. Wed; 10-11 pm, music, educational. Central.

**KFCZ**, Omaha, Neb. 258 meters. 100 watts. Central I. S. Mon, Tues, Wed, Thurs, Fri, 3-4 pm. Mon, Tues, Thurs, 7:30-9 pm, Central.

**KFDA**, Baker, Ore. 360 meters. 5 watts. Adler's Music Store. Daily ex Sun, 5-6 pm, 7:30-8, music. Sun, 6-8 pm, Pacific.

**KFDD**, Boise, Idaho. 252 meters. 10 watts. St. Michael's Cathedral. Sun, 11:15-12:30 pm, 7:30-9:15, church services. Mountain.

**KFDH**, Tucson, Ariz. 268 meters. 50 watts. Univ. of Ariz. Irregular schedule.

**KFDJ**, Corvallis, Ore. 360 meters. 50 watts. Oregon Agri. College. Mon, 8-9 pm, Thurs, 8-9 pm, Pacific.

**KFDO**, Bozeman, Mont. 248 meters. 50 watts. H. Everett Cutting. Mon, Wed, 8-9 pm. Mountain.

**KFDR**, York, Neb. 300 meters. 10 watts. Bullock's Slogan, "The Little Station with the Big Kick." program. Central.

**KFDV**, Fayetteville, Ark. 360 meters. 200 watts. Gilbrech & Stinson. Slogan, "Southern Gateway to the Ozarks." "Land of a Million Smiles." No regular schedule.

**KFDX**, Shreveport, La. 360 meters. 100 watts. First Baptist Church. Wed, 9-10 pm. Sun, 11 am; 7:30 pm, Central.

**KFDY**, Brookings, S. D. 360 meters. 100 watts S. D. State College of Agr. & Mech. Arts. Tues, 11 am, music, lectures, news. Central.

**KFDZ**, Minneapolis, Minn. 231 meters. 10 watts. Harry O. Iverson. Mon, 8:15-9:15; Sun, 5:30-6:30 pm, pipe organ. Central.

**KFEC**, Portland, Ore. 248 meters. 50 watts. Meier & Frank Co. Inc. Daily ex Sun, 12 m, weather, reports; 4-5 pm, music; 6:30 pm, weather, crop, markets, reports. Thurs, 9-10 pm, concert. Sat, 11 am 12 m, children's hour. Pacific.

**KFEG**, Oak Neb. 360 meters. 150 watts. J. L. Scroggin. Wed, 9-10 pm, Central.

**KFER**, Fort Dodge, Ia. 231 meters. 10 watts. Auto Electric Service Co.

**KFEV**, Casper, Wyo. 263 meters. 250 watts. Casper Radio Club. Daily, 8:30 am, weather warnings, entertainment. Tues, evening program. Sun, 3 pm, services; 8 special program. Mountain.

**KFEW**, Minneapolis, Minn. 261 meters. 100 watts. Augsburg Seminary. Tues, 8:15-9:30; 9:30-10:45 alternately, music. Central.

**KFEY**, Kellogg, Ida. 360 meters. 10 watts. Bunker Hill & Sullivan Mining & Con. Co. Slogan, "Voice of the Coeur D'Alene." Mon, Wed, Sat, Sun, 7:30-8:30 pm, Pacific.

**KFEZ**, St. Louis, Mo. 248 meters. 250 watts. Associated Engineering Societies. Wed, 8:30-9:30 pm, Engineering program. Central.

**KHSTAD**, Rialto Theater. "Where the Big Apples Grow." Mon, Wed, Fri, 6:30-7 pm, mu. lc. Special program 11 pm, Pacific.

**KHND**, St. Joseph, Mo. 226 meters. 100 watts. Utz Electric Co. Mon, Fri, 8-9:30 pm, concert. Central.

**KHNF**, Shreveport, La. 266 meters. 150 watts. Central Christian Church. Sun, 10:55 am, 7:30 pm, Central.

**KHNH**, Neah Bay, Wash. 261 meters. 50 watts. Ambrose A. McCue. Tues, Thurs, 9-10 pm; Sat, 9-11 pm, dance. Pacific.

**KHNI**, Santa Barbara, Calif. 360 meters. 100 watts. Fallon & Co. Wed, Fri, 6-6:45 pm, Wed, Sat, 10-11 pm, dance music. Sun, 10 am, church services. Pacific.

**KHNR**, Seattle, Wash. 263 meters. 100 watts. Star Elec. & Radio Co. Slogan, "The Voice of the Charmed Land." Daily ex Sun, 4:30-5:30 pm. Mon, Wed, Fri, 6:30-7:30 pm, Tues, Thurs, Sat, 6:30-8:30 pm. Sun, 1-3 pm, 4:30-7:15. Pacific.

**KHNS**, Lihue, Hawaii. 275 meters. 30 watts. Cliff J. Dow.

**KHNT**, Hutchinson, Kans. 229 meters. 150 watts. Robert Nelson.

**KHNL**, Los Angeles, Calif. 469 meters. 500 watts. Earle C. Anthony, Inc. Slogan, "The Radio Central Station." Daily ex Sun, 5-6 pm, 6:45-7:30 pm, 8-11 pm, Wed, Fri, Sat, 8-12 pm. Sun, 10-10:45 am, 4-5 pm, 6:45-7:30, 8-11. Pacific.

**KHNL**, Iola, Kans. 210 meters. 20 watts. Ross Arbuckle's Garage. Slogan, "The Garden Spot of the State." Daily, 5:15-5:45 pm, Tues, 9-10 pm. Central.

**KHNF**, Portland, Ore. 360 meters. 200 watts. Benson Tech. Student Body.

**KHLL**, Louisville, Kans. 234 meters. 50 watts. Windlach Elec. Farm Equip. Co. Wed, Sat, 8-10:30 pm. Sun, 11-12 m, church services. Central.

**KHLO**, Spokane, Wash. 252 meters. 50 watts. North Central High School.

**KHLP**, Yakima, Wash. 242 meters. 50 watts. Yakima Valley Broadcasting Assn. Slogan, "The Station That Will Make 24 Famous." Mon, Wed, Fri, 7:30-8:30 pm, concert. Sat, 7:30-8 pm, S. S. lesson. Sun, 4-5 pm, music. Pacific.

**KHLU**, Juneau, Alaska. 226 meters. 10 watts. Alaska Elec. Light & Power Co. Mon, Wed, Fri, 8-9 pm. Alaskan.

**KHLY**, Independence, Mo. 240 meters. 250 watts. Reorganized Church of Jesus Christ of Latter Day Saints. Tues, Thurs, 9 pm. Sun, 11 am, 7:30 pm. Central.

**KHZZ**, Fond du Lac, Wis. 273 meters. 100 watts. Daily Commonwealth and Oscar A. Huelsman. Daily ex Sun, 5 pm, music, news, markets, weather. Central.

**KHZA**, Marshalltown, Iowa. 248 meters. 10 watts. Marshall Elec. Co. Slogan, "Marshalltown, the Heart of Iowa." Tues, Fri, 8:30 pm, Central.

**KHZE**, Seattle, Wash. 270 meters. 100 watts. Seattle Post Intelligencer. Slogan, "In the Charmed Land." Daily ex Sun, 3:30-4:30 pm, music; 8:30-10, programs, dance music. Pacific.

**KHZF**, Oklahoma City, Okla. 252 meters. 20 watts. National Radio Mfg. Co. Slogan, "Radio Headquarters." Daily ex Sun, 3 pm, concert; 6:30, political announcements, news, baseball, weather, road report. Tues, Fri, 8 pm, concert. Central.

**KHZA**, Astoria, Ore. 252 meters. 10 watts. E. E. Marsh and Lashery Theater. Daily ex Sun, 6:30-7:30 pm. Sun, 9:30-10:30 pm, Pacific.

**KHJK**, Bristow, Okla. 233 meters. 100 watts. Delano Radio & Elec. Co. Daily ex Sun, 3-4 pm, music. Thurs, 8-9:30 pm, music. Sun, 7:30 pm, church services. Central.

**KHJL**, Ottumwa, Ia. 242 meters. 10 watts. Hardcoch Mfg. Co. Club, "Boiled Bugs." Mon, Wed, Fri, 7:30-8:30 pm. Central.

**KHJM**, Grand Forks, N. D. 280 meters. 100 watts. University of North Dakota.

**KHJN**, Grand Forks, N. D. 280 meters. 5 watts. Valley Radio Div. of Elec. Constr. Co.

**KHJR**, Stevensville, Mont. 255 meters. 6 watts. Ashl. C. Dixon & Son. Slogan, "The Bitter Root Valley Broadcasting Station." Irregular schedule.

**KHJV**, Dexter, Ia. 224 meters. 10 watts. Thomas H. Warren. Daily ex Sun 9:15 am, 10:25, 1:45 pm, weather, markets. Tues, Fri, 8:30 entertainment. Central.

**KHJW**, Towanda, Kans. 226 meters. 10 watts. Le Grand Radio Co. Mon, Thurs, 8:15-10:15 pm, W. T. 7-8 pm, Sat, 7-8:30 pm. Sun, 7:30-9 pm, church services. Central.

**KHJX**, Cedar Falls, Iowa. 229 meters. 50 watts. Iowa State Teachers College. Educational programs.

**KHJY**, Fort Dodge, Iowa. 246 meters. 50 watts. Tunwall Radio Co. Daily ex Sun, 9-10 am, 12 m, 4-5 pm, markets, news, weather; 9:45, weather. Central.

**KHJZ**, Fort Worth, Texas. 254 meters. 20 watts. Texas National Guard, 112th Cavalry. Wed, 8:30-9:30 pm, Sat, 8:30-10 pm, program. Central.

**KHKA**, Greeley, Colo. 273 meters. 50 watts. Colorado State Teachers College. Daily ex Sun, 8:40-9 am. Sun, 8:30-10:30 pm, concert. Mountain.

**KHKB**, Milford, Kans. 236 meters. 500 watts. Brinkley-Jones Hospital Assn. Slogan, "The Home of Gland Transplantation." Mon, Wed, Fri, 7-8 pm, 8-10, 11-12, 12:45-2:30. Sat, 11-2:30 am, Early 11:11 Concert. Central.

**KHKK**, Conway, Ark. 250 meters. 150 watts. Conway Radio Lab. Tues, Fri, 8 pm, music. Central.

**KHKL**, Butte, Mont. 283 meters. 50 watts. F. F. Gray. Tues, Thurs, 8-10 pm. Mountain.

**KHKN**, Hastings, Neb. 341 meters. 1000 watts. Westinghouse Elec. & Mfg. Co. Mon, Thurs, 9:30-11 pm, broadcasts own program. Rebroadcast KDKA's programs on other nights.

**KHKO**, Colorado Springs, Colo. 234 meters. 32 watts. Nassour Bros. Radio Co. Daily ex Sun, 12-1 pm, 5-6, matinee music. Mountain.

**KHKA**, Butte, Mont. 283 meters. 5 watts. Abner R. Willson.

**KHLE**, Menominee, Mich. 248 meters. 5 watts. Signal Elec. Mfg. Co.

**KHLD**, Franklinton, La. 234 meters. 20 watts. Paul E. Greenlaw.

**KHLE**, Denver, Colo. 263 meters. 100 watts. National Electric Service. Daily ex Wed, 7-7:30 pm. Broadcasts for schools on request. Mountain.

**KHLE**, Salt Lake City, Utah. 361 meters. 50 watts. Erickson Radio Co. Inc.

**KHLE**, Cedar Rapids, Iowa. 240 meters. 20 watts. Everett M. Foster.

**KHLE**, Little Rock, Ark. 261 meters. 20 watts. Rizzell Radio Shop. Mon, 8-9 pm, music. Tues, Thurs, 8-9:30 pm, revival services. Sun, 11:00-12:00 m., 8-9:30 pm., church services. Central.

**KHLE**, Albuquerque, N. M. 254 meters. 100 watts. University of New Mexico. Slogan, "The Sunshine Center of America." Fri, 8 pm, educational program. Mountain.

**KHLE**, San Benito, Texas. 236 meters. 60 watts. Rio Grande Radio Supply House. Slogan, "Heart of the Magic Valley." Tues, 7-8 pm, talk. Sun, 7-9 pm, service. Central.

**KHLE**, Rockford, Ill. 229 meters. 100 watts. Rev. A. T. Frykman. Sun, 12:30 pm, Service for Shut-outs (Swedish); 9:45, Service (English). Central.

**KHLE**, Galveston, Tex. 240 meters. 10 watts. George R. Leigh.

**KHLE**, Fargo, N. D. 231 meters. 20 watts. Fargo Radio Supply Co. Irregular schedule.

**KHLE**, Atlantic, Ia. 273 meters. 100 watts. Atlantic Automobile Co. Slogan, "The Garden Spot of Iowa." Wed, 6:15-7 pm, dinner program; 9-11, music. Sat, 11-12:30, midnight, dance music. Sun, 3 pm, church service. Central.

**KHLE**, Little Rock, Ark. 254 meters. Christian churches of Little Rock.

**KHLE**, Fayetteville, Ark. 263 meters. 100 watts. U. of Arkansas. Tues, 9 pm. Central.

**KHLE**, Sioux City, Ia. 261 meters. 10 watts. Minnesota College. Tues, 7 pm. Tues, Thurs, Fri, Sat, 9:15 au. Central.

**KHLE**, Duluth, Minn. 275 meters. 100 watts. Fremont Dept. Store. Daily ex Sun, 11 am-12, weather, concert. Mon, Fri, Sat, 8-9 pm, concerts. Central.

**KHLE**, Minneapolis, Minn. 231 meters. 5 watts. Dr. George W. Young. Thurs, 8:15-9:30 pm, Sun, 12:15-1:45 pm, 2-3:30. Central.

**KHLE**, San Marcos, Tex. 240 meters. 20 watts. Stevens Bros.

## CHALLENGE!

ONE DOLLAR will be paid to the Radiophon submitting the most errors in any one station's listing. Letters must reach Radio Digest office not later than one week from date of issue corrected. Readers are not limited to correcting one station, but such corrections must be verified by the stations themselves, and NOT by comparison to other so-called accurate broadcasting directories and lists. Until June 15, no daylight saving time errors will be admitted, as the changes over the country require some time to be made in the Digest.

That's just how sure Radio Digest is that this Radiophone station directory is correct! To make the challenge fair for everyone, broadcasting stations and their employees are barred from this offer. Why? Because the broadcasters are the source of all the data given herein. They are (or should be) interested enough to answer the inquiry sent them every time data on their station appears. This inquiry contains a proof of their last listing and must either be corrected or oked as correct and

returned to the Digest. Nevertheless, sometimes the stations are careless and mistakes are made. But Radio Digest is so sure of the exactness of this directory that this challenge is made unconditionally.

With reference to the directory: It appears in four parts, serially continuously; the first three parts are station data listings, arranged alphabetically; the fourth part is a state, city index of stations. The information contained in each station data listing is given in the following order: Call letters, city, state, wave length used, watts antenna input, owner's name, slogan used if any, name of listener in "club," schedule of operating hours, and kind of time used, as "Central," "Mountain," etc.

Four successive issues of Radio Digest will give one the most complete and accurate list of broadcasting stations obtainable. This service is original with this publication, and has been maintained from the start. Right of reproduction without permission of any or all of the data contained herein is denied.

**KFAJ**, Boulder, Colo. 360 meters. 100 watts. Univ. of Colo. Tues, Thurs, Sat, 9 pm, time, music, addresses by faculty. Sat, 2:30-5 pm, sports. Mountain.

**KFAN**, Moscow, Ida. 360 meters. 50 watts. The Electric Shop.

**KFAR**, Hollywood, Calif. 280 meters. 100 watts. Studio Lighting Service Co.

**KFAU**, Boise, Ida. 270 meters. 150 watts. Boise H. S. Slogan, "Follow the Oregon Trail to Boise." Daily ex Sat, Sun, 3:30-4:15 pm, markets, weather, news. Mon, Wed, Fri, 8-9 pm, concert. Mountain.

**KFAW**, Santa Ana, Calif. 280 meters. 10 watts. Radio Deal. Daily ex Sun, 4:30-5 pm, news, reports, music. Mon, Thurs, 6:30-7:30 pm, concert. Pacific.

**KFAY**, Medford, Ore. 283 meters. 50 watts. W. J. Virgin. Temporarily discontinued.

**KFBB**, Havre, Mont. 360 meters. 50 watts. F. A. Buttery Co. Daily ex Sun, 1 pm, markets, weather, reports. Fri, 8 pm, entertainment. Mountain.

**KFBC**, San Diego, Calif. 278 meters. 20 watts. W. K. Azbill. Thurs, Sun, 8-9 pm, Bible lesson, sermon. Pacific.

**KFBE**, San Luis Obispo, Calif. 212 meters. 50 watts. H. H. Horn. Sun, Wed, 8-9 pm, music. Pacific.

**KFBB**, Tacoma, Wash. 360 meters. 50 watts. First Presbyterian Church. Sun, 11 am-12:30 pm, 7:15-9. Pacific.

**KFBC**, Sacramento, Calif. 283 meters. 100 watts. Kimball-Union Co. Slogan, "Heart of California." Daily ex Sun, 6:45 pm, concert, news, codes. Wed, 8-9:30 pm, concert. Pacific.

**KFBL**, Everett, Wash. 224 meters. 10 watts. Lesse Bros. Daily ex Sun, 7:15-8:15 pm. Sun, 2-3 pm. Pacific.

**KFBS**, Trinidad, Colo. 360 meters. 15 watts. Chronicle News & Gas & Elec. Supply Co. Mon, 8-10 pm. Mountain.

**KFBU**, Laramie, Wyo. 283 meters. 50 watts. The Cathedral. Irregular schedule.

**KFCB**, Phoenix, Ariz. 238 meters. 10 watts. Nielson Radio Supply Co. Slogan, "When It's Whittertime in Michigan, It's Summertime Down Here." Daily, 7-7:30 pm, bedtime stories. Mountain.

**KFCF**, Walla Walla, Wash. 360 meters. 100 watts. Frank A. Moore. Mon, Fri, 8-9:30 pm, Pacific.

**KFCG**, Billings, Mont. 360 meters. 10 watts. Electric Service Station, Inc. Wed, Fri, Sun, 7:30-9 pm, music. Sun, 11 am-12:30 pm. Mountain.

**KFCM**, Richmond, Calif. 360 meters. 100 watts. Richmond Radio Shop. Slogan, "Out Where the West Ends." Daily ex Sun, 1-2 pm, music. Tuca, Fri, 8-9 pm, music. Pacific.

**KFCP**, Ogden, Utah. 360 meters. 25 watts. Ralph W. Flygare.

**KFCV**, Houston, Tex. 360 meters. 10 watts. Fred Mahaffey, Jr. Daily ex Sun, 7:30-8 pm, markets, entertainment. Sun, 2-3 pm, entertainment. Central.

**KFFB**, Boise, Ida. 273 meters. 10 watts. Jenkins Furn. Co. (Owyhee Hotel). Tues, Thurs, Sat, 8-10 pm, concert. Pacific.

**KFFE**, Pendleton, Ore. 360 meters. 10 watts. Eastern Ore. Radio Co. Daily 8:30-9:30 pm, music. Pacific.

**KFFO**, Hillsboro, Ore. 229 meters. 5 watts. Dr. E. H. Smith. Daily, 6-7 pm, music, sports, news. Fri, 9-10 pm, Chamber of Commerce Community Program. Pacific.

**KFFP**, Moberly, Mo. 260 meters. 50 watts. First Baptist Church.

**KFFQ**, Colorado Springs, Colo. 360 meters. 100 watts. The Marksheffel Motor Co. and W. D. Pyle. Wed, 11-12 midnight. Mon, Fri, 8-9:30 pm, special program. Mountain.

**KFFR**, Sparks, Nev. 226 meters. 100 watts. Jim Kirk. Thurs, 7-8 pm, "Sagebrush Canaries." Pacific.

**KFFV**, Lamoni, Iowa. 360 meters. 100 watts. Grace-land College. Tues, 7 pm, musicale. Thursday, 7 pm, educational program. Sun, 6:30 pm, religious services. Central.

**KFFX**, Omaha, Neb. 278 meters. 100 watts. McGraw Co. Daily, 2:30-3:50 pm, Central.

**KFFY**, Alexandria, La. 275 meters. 50 watts. Pincus & Murphy, Inc. Mon, Thurs, 7-8:30 pm. Central.

**KFFZ**, Dallas, Tex. 226 meters. 20 watts. Al. G. Barnes Amusement Co. (Portable Set).

**KFGC**, Baton Rouge, La. 254 meters. 100 watts. Louisiana State University. Fri, 8-9 pm. Central.

**KFGD**, Chickasha, Okla. 248 meters. 200 watts. Okla. College for Women, Chickasha Radio & Elec. Co. Tues, Thurs, Sat, 8 pm, music, lectures. Wed, 10 am chapel service; 11 pm, special jazz program. Central.

**KFGH**, Stanford Univ., Calif. 360 meters. 500 watts. Leland Stanford Junior University. No regular schedule. Central.

**KFGL**, Arlington, Ore. 234 meters. 10 watts. Arlington Garage. Fri, 7:30-8:30 pm, Pacific.

**KFGG**, Boone, Ia. 226 meters. 10 watts. Cray Hardware Co. Wed, 8-9 pm; Sun, 3-4 pm. Central.

**KFGV**, Utica, Neb. 224 meters. 10 watts. Hildreder Radio Supply Co. No regular schedule.

**KFGX**, Orange, Tex. 250 meters. 500 watts. First Presbyterian Church. Sun, 11 am, 7:30 pm, church services. Central.

**KFGZ**, Berrien Springs, Mich. 286 meters. 500 watts. Emmanuel Missionary College. Slogan, "The Radio Lighthouse." "In the Heart of the St. Joe Valley, Where the Big Peaches Grow." Mon, 7:45-9 pm, music. Wed, 8-9 pm, educational program, music. Fri, 9-10 pm, sacred music. Sun, 9:30 am, 7:45-9 pm, talks, music. Central.

**KFHA**, Gunnison, Colo. 252 meters. 50 watts. Western State College of Colorado. "Where the Sun Shines Every Day." Daily ex Sun, 8:30 am weather, markets, Tues, Fri, 7:30 pm, entertainment. Mountain.

**KFHB**, Hood River, Ore. 280 meters. 5 watts. A. S.

(NOTE—The second part of the station data list will appear next week.)





Illustrated

J. J. Caltabario built this odd set to listen in while at the baseball game.  
© Miller Photo



What could be a better combination than Radio and Mah Jongg? Here we have a group of ladies at the Waldorf-Astoria playing Mah Jongg to the tune of Radio music. © U. & U.



Little Miss Jeanne Seavey of Elmhurst, Ill., tuning in on bed-time stories. Baby Jeanne seems quite interested now, but will probably fall asleep before the story is finished. © U. & U.